

---

***Digital***  

---

***plus***  
*by Lenz*

**LH101**

**Operating Manual**

**Version 1.0**

**1<sup>st</sup> Edition 10 18**

**Art. no. 21101**

## Welcome!

We would like to congratulate you on your acquisition of the LH101 manual control by **Digital plus by Lenz**<sup>®</sup>. We hope you will enjoy this model railway control.

The LH101 manual control is the universal input device in the **Digital plus by Lenz**<sup>®</sup> system. With it you can:

- operate your locomotives as well as assemble, operate, and disassemble multiple tractions
- switch points and signals or enable uncoupling tracks
- read out and configure system settings
- read out information of feedback modules and feedback-capable switch decoders.
- programme locomotive and switch decoders as well as feedback modules

The purpose of this operating manual is to explain the use of the LH101 manual control. To get started, first read the section "First Steps". Afterwards, you can familiarise yourself, step by step, with the full range of functions of this manual control and put them to use.

If you still have questions after reading this operating manual, please contact us. We will be happy to help you. There are four different ways of contacting Lenz Elektronik GmbH:

Mail address: Lenz Elektronik GmbH  
Vogelsang 14  
D-35398 Giessen

Phone: ++49 (0) 6403 900 133

A recorded message will inform  
you of our availability

Fax: ++49 (0) 6403 900 155

Email: info@digital-plus.de

## All present?

Please check if all components have been delivered:

- LH101 manual control
- Connecting cable
- Operating manual (this booklet)

If any component is missing, please ask your model railway dealer for a replacement delivery.

---

## Contents

1	Important advice, please read first!	6
2	Function overview of the LH101	8
3	First steps	10
3.1	Connection and initial operation	10
3.1.1	Connection to the LZ100/LZV100 command station	10
3.1.2	Setting the XpressNET address	10
3.2	Operating your first train	11
3.2.1	Calling up a locomotive address:	11
3.2.2	Controlling a locomotive:	11
3.2.3	Changing the direction of travel:	12
3.2.4	Emergency off:	12
3.2.5	Switching the light function of the locomotive decoder:	13
4	Basic operating instructions for the LH101	14
4.1	Entering numeric values	14
4.2	Disconnecting and reconnecting the LH100 during operation	14
4.3	The LH101 LCD display	15
4.4	The rotary knob of the LH101	16
5	Controlling locomotives	17
5.1	Calling up locomotive addresses	17
5.1.1	Entering a new locomotive address using the keypad	17
5.1.2	Choosing locomotive addresses from the "stack" of the LH101	18
5.1.2.1	Scrolling through the stack	18
5.1.3	Selecting a locomotive address from the command station memory	19
5.1.4	Taking over control of a locomotive from another manual control	20
5.2	Changing the locomotive's speed and direction	21
5.2.1	Standard mode	21
5.2.1.1	Locomotive-specific emergency stop	22
5.2.2	Shunting mode	23
5.3	Enabling functions in locomotive decoders	24
5.3.1	Changing function groups	25
5.3.2	Configuring locomotive decoder functions	25
5.3.3	Configuring the "refresh" of functions	26
5.4	Displaying and changing the speed-step mode	28
5.5	Emergency off	29
6	Switching points and signals	30
6.1	Displaying the point setting	31
6.1.1	Using non-feedback-capable point decoders	31
6.1.2	Using feedback-capable point decoders	31

7	Creating, editing and deleting routes .....	33
7.1	Creating a new route.....	34
7.2	Editing a route.....	35
7.2.1	Editing a step in a route .....	37
7.2.2	Deleting a step from a route.....	38
7.2.3	Adding a step to a route.....	39
7.3	Deleting a route.....	39
8	Setting routes .....	41
9	Double traction .....	43
9.1	What is a double traction? .....	43
9.2	Requirements for a double traction .....	43
9.3	Assembling two locomotives in a double traction: .....	44
9.4	Assembling locomotives with different speed steps into a double traction.....	45
9.5	Disassembling a double traction .....	45
9.6	Error messages when assembling a double traction .....	46
10	Multiple traction (MTR) .....	48
10.1	What is a multiple traction?.....	48
10.2	Requirements for a multiple traction:.....	48
10.3	Assembling a multiple traction (MTR) .....	49
10.4	Controlling a multiple traction .....	51
10.4.1	Speed and direction of the MTR.....	51
10.4.2	Switching functions in the MTR.....	52
10.5	Displaying the members of an MTR and switching between locomotives in an MTR .....	52
10.6	Deleting a locomotive from a multiple traction .....	53
10.7	Deleting a complete MTR.....	55
10.8	Error messages relating to multiple tractions .....	56
11	Displaying feedback .....	57
12	Configuring (programming) decoder settings .....	59
12.1	What is programming and what purpose does it serve?.....	59
12.1.1	Difference between "Programming in operational mode" and "Programming on the programming track" .....	60
12.1.2	When to use "Programming on the programming track"?.....	61
12.2	Programming in operational mode - PoM.....	62
12.2.1	Which settings can be changed using PoM?.....	62
12.2.2	Which locomotive decoders can have their settings changed using PoM? .....	62
12.2.3	Programming a numeric value into a CV — step by step approach:.....	62
12.2.4	Reading out CVs using the LRC120 address display .....	64

---

12.2.5	Setting and deleting bits (switches) using PoM — step by step approach .....	65
12.3	Programming on the Programming track .....	68
12.3.1	What is a programming track? .....	68
12.3.2	Where to connect the programming track/the decoder? .....	68
12.3.3	Reading out and changing a locomotive address .....	69
12.3.4	Reading out and programming a CV .....	71
12.3.4.1	Binary (bitwise) displaying and changing of the CV value .....	72
12.4	Error messages while programming on the programming track .....	74
12.4.1	Display of other connected manual controls .....	74
13	LH101 setup (device setting) .....	75
13.1	Setting the speed step mode .....	75
13.2	Setting the club mode .....	76
13.2.1	Setting club mode 1 or 2 .....	77
13.2.2	Setting mode 0 .....	78
13.3	Counting method for bit representation .....	79
13.4	Display brightness .....	80
13.5	Display contrast .....	82
13.6	Displaying the version number .....	83
13.7	Setting the XpressNet address .....	84
13.8	Reset to ex-factory setting .....	85
13.9	Route interval .....	86
14	System setup .....	88
14.1	Enabling and disabling the "AUTO" mode .....	88
14.1.1	System behaviour with "AUTO" mode enabled .....	89
14.2	Displaying the system version number .....	89
14.3	Deleting locomotive addresses from the command station memory .....	90
15	Appendix .....	93
15.1	Error messages on the display .....	93
15.2	Routes form .....	95
15.3	Trouble shooting .....	96
15.4	Tree structure of options of the LH101 .....	98

## 1 Important advice, please read first!

The LH101 manual control is a component of the *Digital plus by Lenz*<sup>®</sup> system and was submitted to intensive testing before delivery. Lenz Elektronik GmbH guarantees fault-free operation if you follow the advice below:

Depending on the command station and the software version used, certain functions of the LH101 will not be available or only partially available. Relevant information is contained in the beginning of each section.

The LH101 may only be operated with *Digital plus by Lenz*<sup>®</sup> system components. Any use other than that described in this operating manual is not permitted, and all guarantees will become invalid if the LH101 is used inappropriately.

Connect your LH101 only to devices designated for such connection. This operating manual will tell you which devices are suitable. Even if other devices (including those of other manufacturers) are equipped with the same plug connectors, you must not operate the LH101 with these devices. The same plug connector does not automatically mean that operation is permitted. This also applies to other model railway controls.

Do not expose the LH101 to moisture or direct sunlight.

### **If you have problems**

First check this operation manual to see if you may have missed a direction for use. The table of contents and especially the section "Troubleshooting" will help you.

### **Illustration of step-by-step instructions:**

2	<pre>▲ L 0003 U 012 Fgl 0 2 5</pre>	Explanation
---	-------------------------------------	-------------

In this operating manual, all entries made using the keypad are shown on the left. On the right you will see what is shown on the display **after** the entry has been made.

All steps described assume that the manual control is connected to a version 3.6 *Digital plus by Lenz*<sup>®</sup> system, and that this system is turned on.

**Illustration of displays and keys in the text:**

In most cases, the LH101 display and the keys are shown as illustrations. If the text makes reference to displays, these are put in double quotes:

"L 0001"

If the text makes reference to keys, these are put in single quotes:

'M'

**Cross references:**

(⇒p. 23)

This arrow refers you to a particular page in this operation manual, where you will find additional information on a specific subject.

**Important advice:**

Text framed and marked with an exclamation mark contains particularly important information and tips.

## 2 Function overview of the LH101

This section provides a short overview of the functions of the LH101. The use of these functions is described further below. Cross references refer you to the corresponding page in this operating manual.

<b>Display</b>	The LH101 has a large luminous LCD display.
<b>Locomotive addresses</b>	The locomotive address range is 1 to 9999. Address 0 is used to control an analogue locomotive in the digital circuit. (⇒p. 17)
<b>Changing speed and direction</b>	Use the rotary knob to change the locomotive's speed and direction. (⇒p. 21)
<b>Stack</b>	8 stack slots for fast selection of locomotive addresses.
<b>Two operating modes</b>	<p><b>Standard mode:</b> In this mode (ex-factory setting), use the rotary knob to decrease the speed step to 0. (⇒p. 21)</p> <p><b>Shunting mode:</b> In this mode, use the rotary knob to decrease the speed step to 1. Press the rotary knob to stop the locomotive. Let the locomotive slowly approach the desired location, then press the rotary knob to stop the locomotive. The advantage of this mode while shunting: You can decrease the speed until the locomotive stops <b>without having to look at the manual control</b> and without risking that the locomotive stops too early. (⇒p. 23)</p>
<b>Emergency off</b>	Use the emergency off to immediately stop one or all locomotives. (⇒p. 29)
<b>Switching locomotive decoder functions</b>	You can access up to 28 functions in locomotive decoders. (⇒p. 24)
<b>Configuring locomotive decoder functions</b>	You can set each function of a locomotive decoder to permanent or temporary operation. (⇒p. 25)
<b>Setting the speed step mode</b>	Use the LH101 to set the speed steps for the locomotive address currently displayed. (⇒p. 25)
<b>Double traction (DTR)</b>	Two locomotives are controlled as if they were one. (⇒p. 43)
<b>Multiple traction (MTR)</b>	Several locomotives are controlled with a common locomotive address. (⇒p. 48)
<b>Switching points and signals</b>	Use the LH101 manual control to switch up to 1024 points, signals and other magnetic articles. (⇒p. 30)
<b>Routes</b>	You can save up to 16 routes with 16 steps each in the LH101. (⇒p. 33)
<b>Club modes</b>	The LH101 is capable of two so-called "club modes" in which certain functions are blocked. This ensures that model railway enthusiasts who are not fully familiar with



---

	the LH101 may also join in the fun (⇒p. 76).
<b>Displaying feedback information</b>	This function of the LH101 manual control allows you to display the status of the inputs of LR100/101 feedback modules (⇒p. 57).
<b>Configuring decoder settings</b>	You can change the address, starting delay, and other locomotive decoder features through programming. Two methods are available:
<b>Programming in operational mode (PoM)</b>	You can configure the settings of your locomotive decoder while the locomotive is placed anywhere on the layout. For example, drive your locomotive in front of a heavy freight train and adjust the starting delay to the train! (⇒p. 62).
<b>Programming on the programming track</b>	The settings of your locomotive decoder are configured on a separate programming track (⇒p. 68).
<b>System settings</b>	The LH101 allows you to configure several system settings. For example, you can configure the behaviour of the emergency stop button, read out the software version of your command station, and much more. (⇒p. 88)

### 3 First steps

In this section, you will learn:

- to connect your LH101 to the LZ100/LZV100 command station
- to operate your first train

The sections further below explain all the functions of the LH101 in detail.

#### 3.1 Connection and initial operation

The LH101 may be connected to the following components of the **Digital plus by Lenz**® system:

LZ100 or LZV100 command station from version 3.6 onwards.

As is the case with all XpressNET devices, the LH101 can be disconnected and reconnected during operation. Use this advantage of the XpressNet: Mount several LA152 adapter (art. no. 80152) on your layout. This will enable you to use the LH101 right at the centre of action.

After connection, the manual control will display the locomotive address controlled last. During initial operation, address 1 will be displayed.

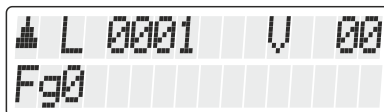

##### 3.1.1 Connection to the LZ100/LZV100 command station

Plug the 5-pin DIN connector

- into the 5-pin DIN socket at the back of your LZ100/LZV100 or, if you have already installed an XpressNET (XBUS) wiring on your layout,
- into a LA152 adapter.

##### 3.1.2 Setting the XpressNET address

All input devices connected to the XpressNet (XBUS) must have their own unique *device address* for the information exchange with the command station to function correctly. You must therefore make sure that all connected devices have different device addresses. Depending on the command station used, up to 31 devices may be connected to the XpressNet. **Ex-factory, each LH101 manual control is set to**

**device address 04.** If you already operate another XpressNET device on this address, you must set your LH101 to a different address.

Information on setting the XpressNET address can be found in the section "Setting the XpressNet " (⇒p. 84).







## 3.2 Operating your first train

In this example we assume that you are using a locomotive with the address 3 (ex-factory address of a decoder).

### 3.2.1 Calling up a locomotive address:

During initial operation, locomotive address "L0001" is displayed.



First, enter the address of locomotive 3:

Action	Display	Explanation
		Press the 'locomotive' key. You can now start to enter the new locomotive address.
		The number entered is displayed. If you entered the wrong number, you can delete the entered digits using the '<=' key.
		Press the 'locomotive' key to complete the entry process. The direction of travel and the speed step are displayed.

In this example, the direction of travel is forward (left arrow points up).

### 3.2.2 Controlling a locomotive:

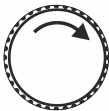
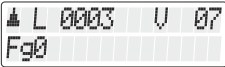
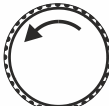
Use the rotary knob to control the speed and the direction of the locomotive.

Action	Display	Explanation
		A clockwise turn increases the speed step.
		A counter clockwise turn decreases the speed step ....

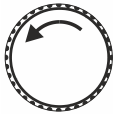

▲ L 0003 U 00  
Fg0

... down to a standstill.

### 3.2.3 Changing the direction of travel:

To change the direction of travel, first set the speed step to "0". You can now change the direction of travel:

Action

Display

Explanation

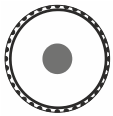

▲ L 0003 U 05  
Fg0 01 3 8

Press the rotary knob to change the direction of travel of the locomotive. The changed direction is shown on the display.

The direction of travel is dependent upon the locomotive, i. e.: For a steam engine, "forward" means "smokestack forward", regardless of the direction in which you have placed this locomotive on the track. If the locomotive is set to speed step 0, each pressing of the rotary knob will change the direction of travel.

### 3.2.4 Emergency off:

Action

Display

Explanation

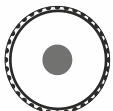

! OFF !

Press the rotary knob **and keep it pressed** until "AUS"/"OFF" is displayed. The track voltage is now turned off.

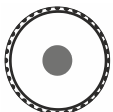

To turn the track voltage back on, press the centre of the rotary knob again ...

▲ L 0003 U 05  
Fg0 01 3 8

... until the locomotive address is displayed again.

### 3.2.5 Switching the light function of the locomotive decoder:

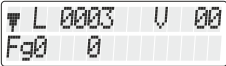
Action	Display	Explanation
		Use the '0' key to switch function 0 (usually the direction-dependent head light of the locomotive) on and off. If this function is enabled, this is shown in the bottom line of the display.

**This was a summary of how to control a locomotive using the LH101.**

## 4 Basic operating instructions for the LH101

First and foremost, the LH101 serves to control locomotives, i. e. to change the speed and the direction of the locomotive and to switch functions in locomotive decoders. Therefore, after being turned on, the LH101 is always set to the operating mode “*Controlling locomotive*”.

Other functions, e. g. multiple traction, switching points and signals, can be reached via the *menu*.

### 4.1 Entering numeric values

Use the keypad to enter numeric values.

The following rule applies:



deletes the last entered digit



cancels the entry process and brings you one level up.

### 4.2 Disconnecting and reconnecting the LH100 during operation

The LH101 makes you mobile!

During operation, the manual control may be disconnected from one XpressNet socket and reconnected to another XpressNet socket. The locomotive address selected last and the speed step currently set are displayed. This ensures that you can follow your train and be right at the centre of action at all times.

This is made possible by the modern technology of the XpressNet.

Use the LA152 adapter (art. no. 80152) to mount additional XpressNet sockets.



### 4.3 The LH101 LCD display

The LH101 has a two-line luminous LCD display.

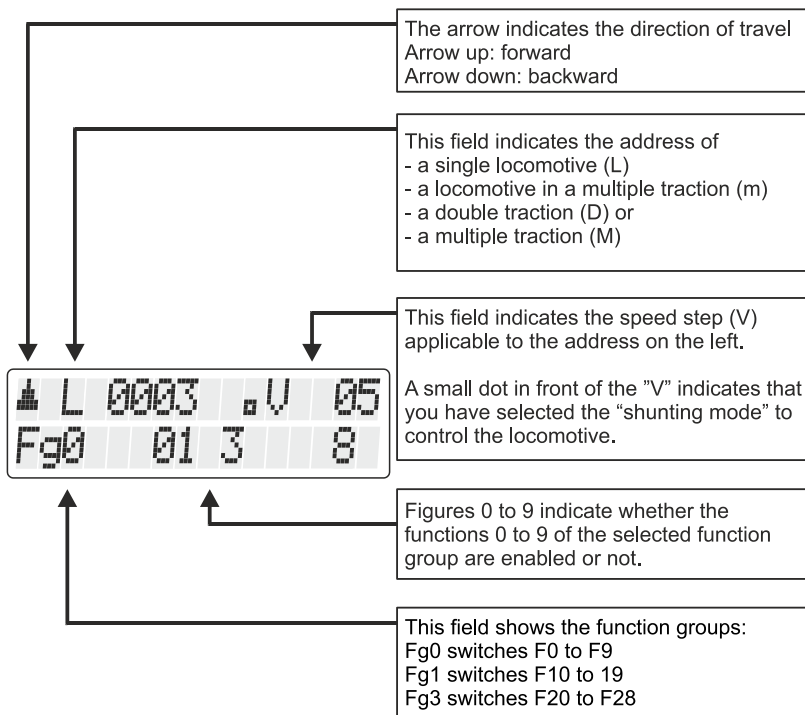

Depending on the operating mode you are in, the display will look different.

The locomotive address is displayed using 4 digits. If needed, zeros are added in front of the address.

**Examples of typical displays while controlling your locomotive:**

▲	L	0003	U	16					
Fg0		01							

A single locomotive (L) with address 0003 is being controlled.

The direction of travel is forward.

The speed step is 16 of 28.

Function group 0 has been selected; functions F0 and F1 are enabled.

▲	L	0260	U	02					
Fg2		1							

A single locomotive (L) with address 0260 is being controlled.

The speed step is 02 of 28.

Function group 2 has been selected; function F21 is enabled.

▲	M	1234	U	012					
Fg1		0 2		5					

The locomotive with address 1234 operates in a multiple traction.

The speed step is 012 of 128.

Function group 1 is set. Functions F10, F12 and F15 are enabled.

▲	MU	33	U	04					

The multiple traction with address 33 is being controlled. The speed step is 04 of 28.

▼	L	0003	U	00					
Fg0		01 3		8					

The locomotive with address 0003 is being controlled in the "shunting mode".

#### 4.4 The rotary knob of the LH101

When switching from one locomotive to another, the rotary knob will – of course – take over the speed of the new locomotive, adjustment is not necessary.



## 5 Controlling locomotives

Controlling locomotives means changing the speed and the direction of locomotives and switching functions in locomotive decoders (lighting, coupling etc.).

In this section, you will learn:

- three different ways to select (i. e. call up) locomotive addresses.
- more information on controlling the speed and direction.
- how to take over a locomotive from another manual control.
- how to switch functions in locomotive decoders.
- how to assign speed steps to a locomotive address.
- how to use the emergency off function.

### 5.1 Calling up locomotive addresses

If you want to control a locomotive using the manual control, you have to *call up* this locomotive first.



There are three different ways to call up a locomotive:

- Enter the number of the locomotive using the keypad
- Select a locomotive from the "stack" of the LH101
- Select an address from the command station memory.

#### 5.1.1 Entering a new locomotive address using the keypad

The valid address range is 0 to 9999. Address 0 is reserved for conventional analogue locomotives (i. e. locomotives without digital decoders).

In the following example, locomotive address "1234" is entered using the keypad.

Action	Display	Explanation
	<pre>Address?  - Stack1: L 0001</pre>	Press the 'locomotive' key.
<b>1</b>	<pre>Address?  1 Stack1: L 0001</pre>	Start to enter the address.
<b>2</b>	<pre>Address?  12 Stack1: L 0012</pre>	If you make a mistake, use the  key to delete the last entered digit.

**3** Address? 123  
Stack1: L 0123

**4** Adresse? 1234  
Stack1: L 1234

 ▲ L 1234 V 12  
Fg0 0 2

Continue to enter the address.

After you have entered the complete locomotive address, the information about function, direction and speed step associated with this locomotive address is queried from the command station and displayed.

If the display flashes after you have called up the locomotive address, the locomotive has already been called up by another manual control. You can still take over this locomotive: To this end, simply press the rotary knob.

### 5.1.2 Choosing locomotive addresses from the “stack” of the LH101

The LH101 manual control has a so-called “stack” for locomotive addresses. In this stack, you can save 8 locomotive addresses. Use the rotary knob to scroll through the stack. The stack can be compared to an index card box with 8 index cards. You can place any locomotive address in the stack slots.

Ex-factory, locomotive addresses 1 to 8 are placed in the stack.

#### 5.1.2.1 Scrolling through the stack

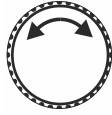
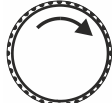
Action	Display	Explanation
	Address? - Stack1: L 0001	Press the 'locomotive' key.
	Address? - Stack2: L 0002	Turn the rotary knob to scroll through the stack. Turn clockwise to scroll forward, turn counter-clockwise to scroll backward.
	Address? - Stack3: L 0003	The display shows the respective stack slot (here: stack 3) and the locomotive address placed therein (here: "0003").

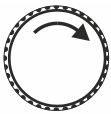

```
Address? -
Stack4: L 0004
```

...

Continue until you have reached the last stack slot.

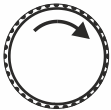

```
Address? -
Stack8: L 0008
```

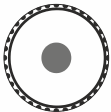

```
▲ L 0008 V 00
Fg0 0 3
```

Press the rotary knob to select the stack slot and the locomotive address placed therein.

If you need more than 8 stack slots, you can use another LH101 and save other locomotive addresses in its stack.

### 5.1.3 Selecting a locomotive address from the command station memory

The command station memory is a storage *in the command station (not the manual control!)*. Each time you call up a locomotive, the locomotive address and associated data (speed step, function status) are saved in this storage.

You can either enter a locomotive address or select a locomotive address from the stack of the manual control or from the command station memory.

Action

Display

Explanation



```
Address? -
Stack1: L 0001
```

Press the 'locomotive' key.



Change to locomotive settings.

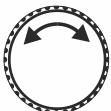

```
command station
Stack ?
```

Turn the rotary knob until the option "Zentralen-Speicher/Command station memory" is displayed.

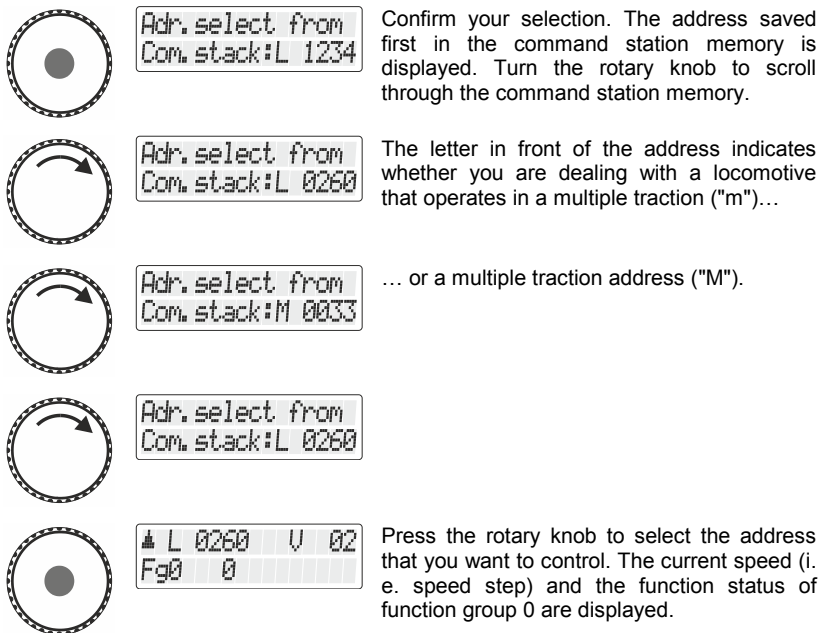

You can also delete a locomotive address from the command station memory. For more information, see the section "Deleting locomotive addresses from the command station memory" (⇒p. 90).

For software version 3.6 of the LZ100/LZV100 you can save up to 100 2-digit locomotive addresses and up to 128 4-digit locomotive addresses in the command station memory.

#### 5.1.4 Taking over control of a locomotive from another manual control

If you call up a locomotive (as described above) that has already been called up by another manual control (or an Interface), the display of the manual control will flash.

Press the rotary knob to take over this locomotive. The display stops flashing and shows the latest operating and function data. Now, the display of the other manual control flashes.

If you do not want to take over the locomotive



Press the 'Esc' key to change back to the locomotive controlled before or



select another locomotive address.

## 5.2 Changing the locomotive's speed and direction

To control the speed and direction, two methods are available:

- the **standard mode** (ex-factory setting):  
In this mode, use the rotary knob to decrease the speed step to 0.
- The **shunting mode**:  
In this mode, use the rotary knob to decrease the speed to 1.  
Press the rotary knob to stop the locomotive.  
Let the locomotive move slowly to the desired location and press the rotary knob to stop the locomotive.  
The advantage of this mode while shunting: You can decrease the speed to the slowest setting without risking that the locomotive stops too early and **without having to look at the manual control**.

Read the section "Setting the speed step mode" starting on page 75 to learn how to set the standard mode as well as the shunting mode.



Do not confuse the shunting **mode** of the LH101 with the shunting **gear** that can be set in locomotive decoders.

### 5.2.1 Standard mode

Use the rotary knob to control the speed and the direction of the locomotive.

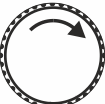
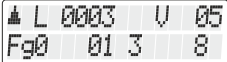
Action	Display	Explanation
		A clockwise turn increases the speed step.

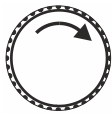

```
▲ L 0003  V 17
Fg0  01 3  8
```

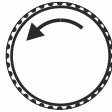

```
▲ L 0003  V 05
Fg0  01 3  8
```

A counter clockwise turn decreases the speed step ...

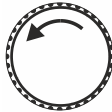

```
▲ L 0003  V 00
Fg0  01 3  8
```

... down to a standstill.

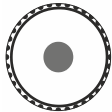

```
▼ L 0003  V 00
Fg0  01 3  8
```

Press the rotary knob while in speed step 0 to change the direction of travel.

### 5.2.1.1 Locomotive-specific emergency stop





Action	Display	Explanation
	<pre>▲ L 0003  V 17 Fg0  01 3  8</pre>	If the speed step of a locomotive is not 0 and you <i>briefly</i> press the rotary knob ...
	<pre>▲ L 0003  V 00 Fg0  01 3  8</pre>	... you effect an emergency stop for the selected locomotive. The locomotive stops without the set braking delay.
	<pre>▼ L 0003  V 00 Fg0  01 3  8</pre>	Press the rotary knob again to change the direction of travel.

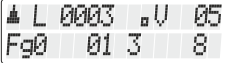

The locomotive-specific emergency stop is not available in the shunting mode. If you press the rotary knob, the locomotive stops with the braking delay set in the locomotive decoder.

### 5.2.2 Shunting mode

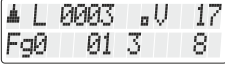
While in shunting mode, use the rotary knob to decrease the speed step to 1. Press the rotary knob to stop the locomotive. Let the locomotive move slowly to the desired location and press the rotary knob to stop the locomotive. The advantage of this mode while shunting: You can decrease the speed to the slowest setting without risking that the locomotive stops too early and **without having to look at the manual control**.

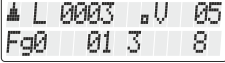
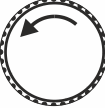
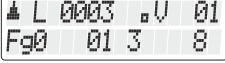
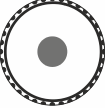
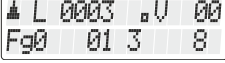
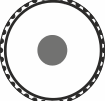
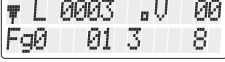
Action	Display	Explanation
		A clockwise turn increases the speed step.
		
		A counter clockwise turn decreases the speed step...
		... to speed step 1.
		Press the rotary knob to stop the locomotive (speed step 0).
		Press the rotary knob again to change the direction of travel.



If, while in shunting mode, the speed step is larger than 0 and you press the rotary knob, the locomotive will stop with the braking delay set in the locomotive decoder.

Read the section "Setting the speed step mode" starting on page 75 to learn how to enable (or disable) the shunting mode.

A small dot on the display indicates whether the LH101 is set to the shunting mode:

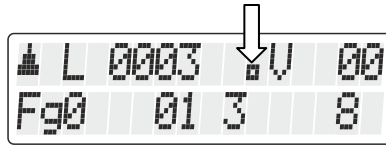

### 5.3 Enabling functions in locomotive decoders

All *Digital plus by Lenz*® locomotive decoders have one or more special functions. The functions are numbered, beginning with 0. Altogether the *Digital plus by Lenz*® system can address up to 28 functions in locomotive decoders.

For the LH101, these 28 functions are divided into 3 function groups. Which of these groups is enabled is indicated at the bottom left of the display:

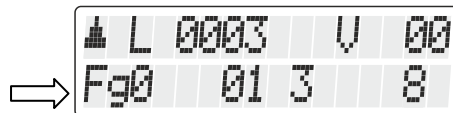

Depending on the selected function group (0 to 2), the following functions are switched:

Key:	0	1	2	3	4	5	6	7	8	9
Function group 0:	0	1	2	3	4	5	6	7	8	9
Function group 1:	10	11	12	13	14	15	16	17	18	19
Function group 2:	20	21	22	23	24	25	26	27	28	

The bottom line of the display indicates the function status: If the function number is visible, the function is enabled; if the number is not visible, the function is disabled.

A function can be set to permanent or temporary operation (⇒ p. 25).



### 5.3.1 Changing function groups

The selected function group is indicated at the bottom left of the display.

Action	Display	Explanation
		Function group 0 is displayed, functions 0, 1, 3 and 8 are enabled.
		<b>Briefly</b> press the 'F' key to change to the next function group: Function group 1 is displayed, functions 12, 13, 15, 17 and 19 are enabled.
		Function group 2 is displayed, functions 20, 21, 22 and 28 are enabled.
		Shows function group Fg0 again.

After the initial operation of the LH101, function group 0 is enabled.

### 5.3.2 Configuring locomotive decoder functions

Functions F1 to F28 can be set to permanent or temporary operation. Function F0 is always set to permanent operation.

#### Permanent operation









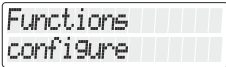
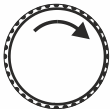

Press the key to enable the function; press the key again to disable the function.

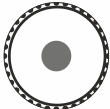
#### Temporary operation

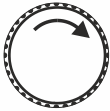
Press the key to enable the function; release the key to disable the function.

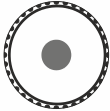
This setting is saved in the command station. When calling up the locomotive, the manual control queries the setting from the command station. This setting can be made individually for each function and each locomotive address.

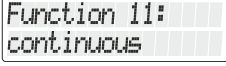
Action	Display	Explanation
		Call up the locomotive address whose function setting you want to display or change.

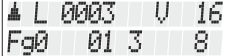
		Press the 'F' key and <b>keep it pressed</b> until the display changes.
		Release the 'F' key and turn the rotary knob until you reach this display.
		Press the rotary knob; the configuration of function 1 is displayed.
		Turn the rotary knob until the function is displayed that you want to set to permanent or temporary operation.
		Press the rotary knob to switch between permanent and temporary operation.
		Turn the rotary knob to select the next function whose configuration you want to change ...
		... or end the configuration process by pressing 'F' ...
		or 'Esc'.

### 5.3.3 Configuring the “refresh” of functions

By “refreshing” functions we mean the following: In defined regular intervals, the command station sends function information via the track to all decoders located on the track. This ensures that a decoder does not “forget” settings, even if the connection between command station and decoder is interrupted intentionally (due to “dead frogs”) or unintentionally (due to dirt or a power interruption). For layouts where many locomotives or decoders are operating simultaneously, it may make sense to disable this cyclic transmission of individual functions to decrease the time delay resulting from the total time required for each transmission (typically 8 mS). This way, you can decide which

function information is transmitted cyclically and which is not. Ex-factory, the LZV100 cyclically transmits information about functions 0 to 8. A “refresh” of functions affects all locomotive addresses.

To “refresh” functions, proceed as follows:

Action	Display	Explanation
		Proceed from “Controlling locomotive”. It does not matter which locomotive address you select.
		Press the 'F' key and <b>keep it pressed</b> until the display changes.
		Release the 'F' key and turn the rotary knob until you reach this display.
		Press the rotary knob to display the current “refresh setting”: Functions F0 to F8 are transmitted cyclically.
		Turn the rotary knob to select another “refresh setting”: Functions F0 to F12 are transmitted cyclically.
		Functions F0 to F20 are transmitted cyclically.
		Functions F0 to F28 are transmitted cyclically.
		Functions F0 to F4 are transmitted cyclically.
		Press the rotary knob to confirm your selection.

## 5.4 Displaying and changing the speed-step mode

The range from stop to maximum speed of a locomotive is divided into *speed steps*. The more steps, the smaller the division.

With the LH101 you can set 2 different divisions (also called „speed step modes“): 28 or 128 speed steps.



The speed step is saved in the command station together with the corresponding locomotive address. This means that you can set the mode 28 speed steps for one locomotive address and the mode 128 speed steps for another locomotive address.

To display or change the speed step mode:

Action	Display	Explanation
		Call up the locomotive address whose speed-step mode you want to display or change.
		Make sure that the locomotive is set to speed step "0". Otherwise, the speed step mode can be displayed but not changed.
		Press the 'locomotive' key.
		Change to locomotive settings.
		Turn the rotary knob to display the option "Fahrstufenmodus/Speed step mode"
		Press the rotary knob to display the speed-step mode currently set.
		Turn the rotary knob to display the available speed step modes.

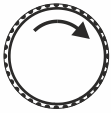

```
Speed step mode
L 0003: 285pst.
```

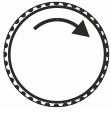

```
Speed step mode
L 0003: 128Spst.
```

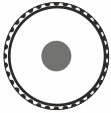

```
▲ L 0003  V 000
Fg0  01 3  8
```

Press the rotary knob to assign a specific speed-step mode to the locomotive address.



In "128 speed steps" mode, speed step "0" and the "emergency stop" are counted as speed steps. The maximum speed step which is therefore displayed in this mode is "126".

## 5.5 Emergency off

Action

Display

Explanation

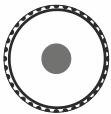

```
▲ L 0003  V 05
Fg0  01 3  8
```

```
! OFF !
```

Press the rotary knob **and keep it pressed** until "OFF" is displayed.

The track voltage is now turned off.

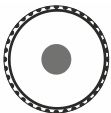

```
▲ L 0003  V 05
Fg0  01 3  8
```

To turn the track voltage back on, press the centre of the rotary knob again until the locomotive address is displayed again.

## 6 Switching points and signals

You can use the LH101 manual control to digitally switch magnetic articles, e. g. points, signals or relays. These articles must be connected to a switch decoder (e. g. to the LS100/LS150 of the *Digital plus by Lenz*® system or to other compatible modules). You can switch a total of 1024 points, signals and other magnetic articles using the *Digital plus by Lenz*® system.

Action	Display	Explanation
		Proceed from „Controlling locomotive“.
		Use the 'points/signals' key to change to the menu for switching points and signals.
	The locomotive address currently used, including its direction and speed step, are displayed in the top line of the display.	
		Start to enter the address.
		If you enter a wrong address, use the  key to delete the entered digits.
		Continue until you have entered the last digit.
		Press the points/signals key again to confirm your entry. A + or a – after the point address indicates its setting.
		Press the 'M' key to change the point/signal setting.
		Press the '<=' key to enter another point address ...
	...or...	
		press the 'Esc' key to complete the switching of points and signals.



While switching points and signals, it is still possible to control the speed and direction of the displayed locomotive using the rotary knob. This allows you to switch points during shunting manoeuvres.

## 6.1 Displaying the point setting

### 6.1.1 Using non-feedback-capable point decoders

In this case, the last command sent to the switch decoder is displayed. The display of the LH101 changes automatically when the point or signal setting is changed by another LH101 (or another XpressNet device).

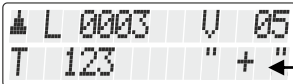

Display of the point setting

### 6.1.2 Using feedback-capable point decoders

When using the feedback-capable LS100 switch decoder, the actual point setting can be displayed.



Requirements:

- Use of a feedback-capable LS100 switch decoder
- Wiring of the feedback bus (R,S) to the command station
- End-of-stroke-off point drives or
- feedback contacts at the point drives

Let us assume that point no. 18 has an end-of-stroke-off drive and is correctly connected to a LS100 switch decoder. Enter the point number (see above). The command station informs the manual control that it is dealing with a feedback-capable switch decoder and now shows the following:

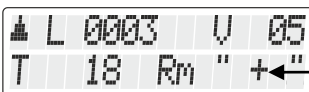

Display of the point setting

'Rm' indicates that you have called up a point number of a feedback-capable LS100 switch decoder.

When calling up the point, the position + may be displayed. If you now press the **M** key to switch the point, the display changes to – (if the switching has actually taken place). Otherwise, the initial display remains. This way you can immediately see if a point setting has changed or not. The display also changes if you switch the point manually.



The display changes only when the final position of the point drive has been reached.

For information on wiring the feedback bus, please refer to the operating manuals of the feedback-capable devices.

If after entering i. e. the point address '257' you see this display

```
▲ L 0003  U 05
Rm 0257  "----"
```

the address is not a switch decoder, but a LR100/LR101 feedback module.

In this case, pressing the **M** key has no effect.



```
▲ L 0003  U 05
Turnout address?
```

Press the '<=' key to enter another point address ...

...or...



```
▲ L 0003  U 05
Fg0 01 3 8
```

press the 'Esc' key to complete the switching of points and signals.

Information on how to display the status on feedback modules can be found in the section "Displaying feedback" (⇒ p. 57)





## 7.1 Creating a new route



**BEFORE** you create a route, note down the respective point number as well as the required setting. The Annex (⇨ p. 95) includes a form that you can copy for this purpose. The download area on our website also contains a PDF form that you can use.

Action	Display	Explanation
	<pre>▲ L 0003 U 05 Fg0 01 3 8</pre>	Proceed from "Controlling locomotive".
	<pre>▲ L 0003 U 05 Turnout address?</pre>	Use the 'points/signals' key to change to the menu for switching points and signals.
	<pre>Pre-set routes</pre>	Press the 'points/signals' key again to change to creating (or editing/deleting) routes.
	<pre>Pre-set route add</pre>	Use the rotary knob to select "Fahrstrasse neu anlegen/Creating route".
	<pre>Pre-set route 01 add</pre>	Press the key to confirm your selection. The number of the next available route is displayed at the top right. You can take over this number or turn the rotary knob to select another available number.
	<pre>PR 01 Step 01 Turnout address?</pre>	Press the key to confirm your selection ...
	<pre>PR 01 Step 01 Turnout addr 1</pre>	... and start to enter the point address for step 1. If you enter a wrong address, use the '<=' key to delete the entered digits.
	<pre>PR 01 Step 01 Turnout addr 12</pre>	Continue until you have entered the last digit.
	<pre>PR 01 Step 01 T 12 " + "</pre>	Press the points/signals key again to confirm your entry. A + or a - after the point address indicates its setting.



```
PR 01 Step 01
T 12 " - "
```

Press the 'M' key to enter the desired point/signal setting.



Press the 'M' key again to send a corresponding switch command to the point/signal. This way you can verify if you have selected the correct point and the correct setting.



Press the 'point/signal' key to confirm the entries relating to this step.

**The step is now saved.**

```
PR 01 Step 02
Turnout address?
```

The next step of the route is offered for entry. You can now proceed to the next step of the route and enter the next point address...

...or...



```
Pre-set route 01
saved
```

... press the 'M' key to save the route and to proceed to enter another route...

(The display remains visible for 2 s)

...or...



```
▲ L 0003 U 05
Fg0 01 3 8
```

... press the 'Esc' key to leave the routes menu and return to "Controlling locomotive". The route will be saved.

## 7.2 Editing a route

In this section, you will learn how to:

- edit a step in the route
- delete a step from a route
- add a new step to a route

The beginning of the editing process is the same for all three options:

Action

Display

Explanation

```
▲ L 0003 U 05
Fg0 01 3 8
```

Proceed from "Controlling locomotive".



```
▲ L 0003 U 05
Turnout address?
```

Use the 'points/signals' key to change to the menu for switching points and signals.



```
Pre-set routes
```

Press the 'M' key again to change to creating (or editing/deleting) routes.

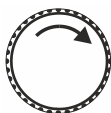

Pre-set route  
edit

Turn the rotary knob to select "Fahrstrasse bearbeiten/Edit route".

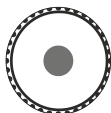

Pre-set route 01  
edit

Press the key to confirm your selection and ...

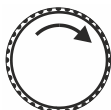

Pre-set route 02  
edit

... use the rotary knob to select the route that you want to edit.

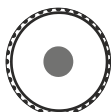

Press the rotary knob to confirm your selection.

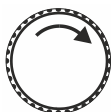

Turn the rotary knob to select one of the following options:

Pre-set route 02  
change step

... "Schritt ändern/Edit step" ...

continue with "Editing a step in a route ", page 37

Pre-set route 02  
delete step

... "Schritt löschen/Delete step" ...

continue with "

Deleting a step from a route ", page 38

Pre-set route 02  
new step

... and select "Schritt neu/New step"

continue with "Adding a step to a route ", page 39.



**The option "Schritt neu/New step" is displayed only if the maximum amount of steps in a route has not yet been reached!**

### 7.2.1 Editing a step in a route

Proceed initially as described in the section "Editing a route", page 35 and select the option "Change step".

```
PR 02 Step 01
T 42 " + "
```

The first step in the route selected for changing is displayed.

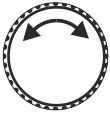

```
PR 02 Step 05
T 74 " + "
```

Scroll to the step that you want to change.

If you only want to change the point setting, proceed with (2) =>

(1)



```
PR 02 Step 05
T _ " + "
```

If you want to change the point address of this step, delete the address displayed and ...



```
PR 02 Step 05
T _7 " + "
```

start to enter the new point address.



```
PR 02 Step 05
T _75 " + "
```



```
PR 02 Step 05
T 75 " + "
```

Press the 'point/signal' key to confirm your entry.

(2)



```
PR 02 Step 05
T 75 - "
```

Press the 'M' key to change the setting.



Press the 'M' key again to send a corresponding switch command to the point/signal. This way you can verify if you have selected the correct point and the correct setting.



Press the 'point/signal' key to confirm your entry.

**The change is saved.**

```
PR 02 Step 06
T 1234 " + "
```

The next step of the route is offered for entry. You can edit this step ...

...or...

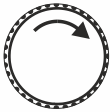

... select another step for editing ...

...or...

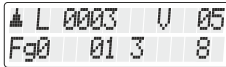

... press the 'Esc' key to leave the menu "Fahrstraßen bearbeiten/Edit routes" and return to "Controlling locomotive".

## 7.2.2 Deleting a step from a route

Proceed initially as described in the section "Editing a route", page 35.

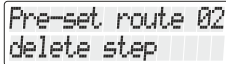
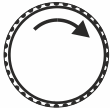

Select the option "Schritt löschen/Delete step" ...

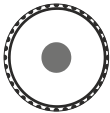

... press the rotary knob to confirm your selection.

The first step of the selected route is displayed.

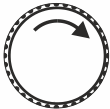

Scroll to the step that you want to delete.

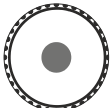

Confirm the selection of the step. A security query is displayed.

You can now

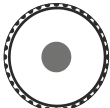

press the rotary knob to permanently delete the selected step ...

and select another step for editing ...

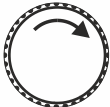

...or...



```
PR 02 Step 05
T 74 " + "
```

... press the 'Esc' key to cancel the deletion process and return to selecting a step.

### 7.2.3 Adding a step to a route



The option " New step" is displayed only if the maximum amount of steps in a route has not been reached!

Proceed initially as described in the section "Editing a route", page 35.

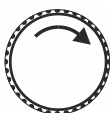

```
Pre-set route 02
new step
```

Select the option "Schritt neu/New step".

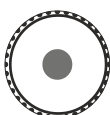

```
PR 02 Step 06
Turnout address?
```

The next available step number is displayed.

Proceed as described in the section "Creating a new route", page 34.

## 7.3 Deleting a route

Action

Display

Explanation

```
▲ L 0003 V 05
Fg0 01 3 8
```

Proceed from "Controlling locomotive".



```
▲ L 0003 V 05
Turnout address?
```

Use the 'points/signals' key to change to the menu for switching points and signals.



```
Pre-set routes
```

Press the 'M' key to change to creating (or editing/deleting) routes.

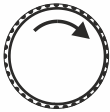

```
Pre-set route
delete
```

Use the rotary knob to select "Fahrstrasse löschen/Delete route".

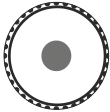

Press the key to confirm your selection and ...

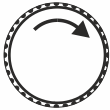

```
Pre-set route 05
delete
```

select the route that you want to delete.

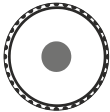

```
Pre-set route 05
really delete ?
```

Press the key again to confirm the deletion. The selected route is deleted.

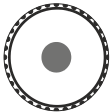

```
Pre-set routes
```

You are now back in the routes menu.

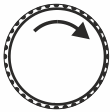

You can now select another action in the routes menu ...

...or...

**Esc**

```
▲ L 0003 V 05
Fg0 01 3 8
```

... press the 'Esc' key to return to "Controlling locomotive".



## 8 Setting routes



Before you can set routes, you have to create routes in the LH101. The creating, editing and deleting of routes is described from ⇒ page 33 onward.

The setting of a route is similar to the setting of points and signals:

Action	Display	Explanation
		Proceed from "Controlling locomotive".
		Use the 'points/signals' key to change to the menu for switching points and signals.
		Turn the rotary knob to scroll through the created routes (if no routes have been created, "Speicher leer/Storage empty" is displayed).
		When you have reached the route created last ...
		... you will again see the first one.
		Press the rotary knob to set the route.
		The point addresses and settings saved in the route are ...
		... displayed one after the other.

```
▲ L 0003  U 05
PR 01 set
```

When the route has been created, a confirmation is displayed.

**You can now ...**

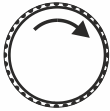

```
▲ L 0003  U 05
Pre-set route 02
```

... turn the rotary knob again to select the next route.

...or...



```
▲ L 0003  U 05
Turnout address?
```

press the '<=' key to go back up a level so you can switch individual points.

...or...



```
▲ L 0003  U 05
Fg0  01 3  8
```

... press the 'Esc' key to exit the routes menu and return to "Controlling locomotive".

## 9 Double traction

The LH101 allows you to add two locomotives to a double traction and to control them as if they were one locomotive.

In this section, you will learn:

- what a double traction is
- the requirements for a double traction
- how to assemble a double traction
- how to switch between the two locomotives in a double traction
- how to disassemble a double traction

### 9.1 What is a double traction?

In a double traction (DTR), you control two locomotives of your choice as if they were one locomotive. The command station ensures that the two locomotives in the DTR receive the same operating data.

All DCC locomotive decoders are DTR-capable. Configuration of the decoders themselves is not required. That is to say:



The decoder itself does not “know” that it operates in a double traction. In this way, a double traction differs from a multiple traction (⇒p. 48)

### 9.2 Requirements for a double traction

- You must have called up – on the same manual control – each of the two locomotives that you want to add to the double traction.
- You must have given an operating command to each locomotive (i. e. change the speed or direction or turn a function on or off).
- When being added to the double traction, the speed step of both locomotives must be 0.



You cannot add a conventional analogue locomotive (address 0) to a double traction! Any attempt to do so will result in an error message (⇒p. 46).

### 9.3 Assembling two locomotives in a double traction:

Call up the first locomotive (e. g. locomotive no. 24) and drive it to the location on your layout where you want to couple it to the second locomotive.

Now, call up the second locomotive (e. g. locomotive no. 78) and drive it next to the first locomotive.

In this manner you make sure that you have both locomotives called up by your manual control and that you have given each of them an operating command.

Make sure that both locomotives are set to run in the same direction.

It is, of course, possible that the direction arrow of one locomotive points up and the direction arrow of the other locomotive points down, since the direction of travel is locomotive-dependent.

Proceed as follows:

Action	Display	Explanation
		Locomotive no. 78 operated last is still shown on the display.
		Turn the rotary knob to display the option "Doppeltraktion/Double traction".
		Press the rotary knob to select the option.
		Use the keypad to enter the locomotive address or turn the rotary knob to select a locomotive address from the stack.
		After entry or selection, locomotive address 78 is displayed as a double traction "D".

Both locomotives can now be controlled simultaneously by turning the rotary knob. You can stop or change the direction of travel as if you were controlling one locomotive.

You can now control the assembled double traction as if it was one locomotive. The two locomotives receive the corresponding operation command one after each other.



When operating a double traction, the rotary knob (increasing or decreasing the speed step, changing the direction of travel) affects both locomotives simultaneously. The keys that turn functions on and off affect only the locomotive whose address is shown on the display.

If you want to change a function of the second locomotive operating in the double traction, you must select this locomotive using the 'Esc' key.

## 9.4 Assembling locomotives with different speed steps into a double traction

You can also add locomotives with different speed steps to a double traction. In this case, the speed step corresponding to the speed is always displayed.

Example:

The locomotive with address 24 has 28 speed steps; the locomotive with address 78 has 128 speed steps. If you see the maximum speed step of 28 when displaying locomotive address 24, you will see speed step 128 after switching to locomotive address 78, since that is the maximum speed step for locomotive address 78.

## 9.5 Disassembling a double traction

To remove locomotives from a double traction, proceed as follows:

Action

Display

Explanation

```

D 0078 V 00
Fg0 0
  
```

Call up one of the two locomotives operating in a double traction on your manual control.



Press the 'M' key.

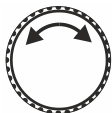

```
Double header
```

Turn the rotary knob until you reach the option "Doppeltraktion/Double traction".

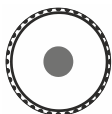

```
Double header
disassembling ?
```

Press the rotary knob to select the option.

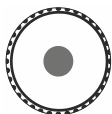

```
Disassembling ?
D 0078 + D 0024
```

A security query is displayed. Press the 'Esc' key to cancel the process.

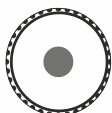

```
 L 0078  V 00
Fg0  0
```

Press the key again to disassemble the double traction; alternatively, press the 'Esc' key to cancel the process.

Once the double traction is disassembled, the display again shows an "L" in front of the locomotive address.



You can disassemble a double traction even if the current speed step is not 0!

## 9.6 Error messages when assembling a double traction

If you made an error when assembling the double traction, you will see one of the following messages on the display:

```
Double header
Error 24
```

- The address of the locomotive was not entered in the stack before it was added to the double traction, or
- the locomotive in the stack has not been operated yet or
- you have tried to add a conventional analogue locomotive (address 0) to a double traction.

```
Double header
Error 25
```

One of the two locomotives that you wanted to add to the double reaction has already been called up by another manual control.

```
Double header
Error 26
```

One of the two locomotives that you wanted to add to the double traction is already part of another double traction.

```
Double header
Error 27
```

The speed step of one of the two locomotives was not 0.

Press the '<=' key to return to "Controlling locomotive".

## 10 Multiple traction (MTR)

Use the LH101 (depending on the software version of the command station used) to control, assemble and delete multiple tractions.

In this section, you will learn:

- what a multiple traction is
- how a multiple traction is assembled and disassembled
- how to switch the functions of a locomotive that is part of a multiple traction

### 10.1 What is a multiple traction?

In a multiple traction, several locomotives are controlled simultaneously with one common address, the **multiple traction address**. All locomotives in the MTR react simultaneously, as if you were controlling one locomotive.

You can choose any address between 1 and 99 as multiple traction address.

When assembling a MTR, each locomotive in the MTR receives this multiple traction address. The address is saved in the locomotive decoder in addition to the locomotive's own address. From now on, the locomotive decoder does not "listen" to its own address, but only to the multiple traction address. Don't worry: The locomotive decoder does not forget its own address, it remains saved.

Speed and direction of travel of an MTR can be controlled using the multiple traction address.



If a locomotive that is part of an MTR has switchable functions (light, smoke generator), you can reach these functions only via the locomotive's own address, *not* via the multiple traction address.

When you disassemble the MTR, the multiple traction address is deleted in the locomotive decoder, and the locomotive responds to its own address again.

### 10.2 Requirements for a multiple traction:

You can assemble multiple tractions with all locomotive decoders of the *Digital plus by Lenz*® programme that were produced as of the end of 1996. You can also use DCC decoders of other manufacturers



provided they support the MTR function. Further information can be obtained from the manufacturers of these decoders.



All locomotives that you want to add to an MTR must be located on the layout! Only then can the locomotive decoders receive the special MTR commands sent over the track!

- The addresses of all locomotives that you want to add to a multiple traction must be in the stack of the manual control that you want to use to assemble the multiple traction.
- You must have given an operating command to each locomotive (i. e. change the speed or direction or turn a function on or off) using this manual control.
- When being added to the multiple traction, the speed step of the locomotives must be 0.

### 10.3 Assembling a multiple traction (MTR)

Drive all locomotives that you want to add to the MTR to the location on your layout where you want to start controlling the MTR.

Ensure that all locomotives are set to run into **the same direction**. If your MTR is meant to drive to the right, the direction of each locomotive must be set to the right. Note that the direction arrow in the LH101's display may point up or down.

Now, begin to assemble your MTR:

Action	Display	Explanation
		Call up the first locomotive that you want to add to the MTR.
		Press the 'M' key.
		Turn the rotary knob until you reach the option "Mehrfachtraktion/Multiple traction".



If the locomotive currently controlled is a conventional analogue locomotive (address 0), the option "multiple traction" is not available.

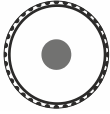

Press the rotary knob to select the option.



```
MU Loco
assembling
```

Turn the rotary knob to display "Lok einfügen/Add locomotive".

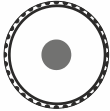

```
Multi unit cons.
MU-Address? _
```

Press the rotary knob to select the option.

You are asked to enter the multiple traction address.

3

```
Multi unit cons.
MU-Address? _3
```

Enter the TR address (1-99).

3

```
Multi unit cons.
MU-Address? 33
```

Use the



key to delete or correct your entry.

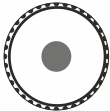

```
Loco include to
MU 33: L 1234
```

Press the rotary knob to confirm the MTR address.

The locomotive called up last is offered to you first.

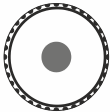

```
Loco include to
MU 33: m 1234
```

If you want to add this locomotive, press the rotary knob.

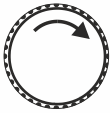

```
Loco include to
MU 33: L 0078
```

Turn the rotary knob to select additional locomotives from the stack to add to the MTR.

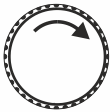

```
Loco include to
MU 33: L 0260
```

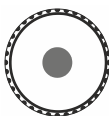

```
Loco include to
MU 33: m 0260
```

Press the rotary knob to add the displayed address to the MTR.

Continue until you have added all desired locomotives to the MTR and ...



```
▲ m 1234 V 00
Fg0 0
```

... complete the assembly process.



Locomotives from the LH101's stack that are already part of a double traction or a multiple traction are not available.

## 10.4 Controlling a multiple traction

To control a multiple traction, call up either the multiple traction address or the address of one of the locomotives that is part of the MTR. The multiple traction address itself is indicated by an upper case "MU" on the display. A lower case "m" indicates that this locomotive address is part of an MTR.

Examples:

```
▲ m 1234 V 012
Fg1 0 2 5
```

The locomotive with address 1234 is part of a multiple traction.

```
▲ MU 33 V 00
```

The multiple traction with address 33 is being controlled.

### 10.4.1 Speed and direction of the MTR

You can control the MTR just like a "normal" locomotive, using the rotary knob.

Changes made to the speed and direction using the rotary knob affect *all locomotives in the MTR* simultaneously. To control the MTR, it is therefore irrelevant whether the MTR address (indicted by an upper case "M") or the address of a locomotive that is part of the MTR (indicted by a lower case "m") is displayed.



### 10.4.2 Switching functions in the MTR

The keys that turn *functions* on or off affect *only that locomotive in the MTR whose address is displayed* (indicted by a lower case "m"). If the MTR address (indicted by an upper case "M") is displayed, you cannot switch functions and no functions are displayed.

If you want to change a function in a locomotive that is part of the MTR, you must call up this locomotive (see the next section). You are then able to turn on or off any function of this locomotive.

## 10.5 Displaying the members of an MTR and switching between locomotives in an MTR

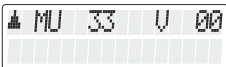
You can display the complete list of locomotives that are part of the MTR as well as the MTR address itself at any time, regardless of whether you see the multiple traction address (indicted by an upper case "M") or one of the locomotives that are part of the MTR (indicted by a lower case "m") on the display:

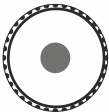
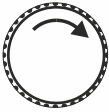
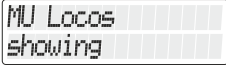
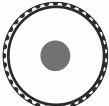
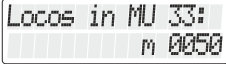
Action	Display	Explanation
		Call up a locomotive that is part of the MTR or the MTR address itself.
		Press the 'M' key. Since you have selected an MTR or a locomotive that is part of the MTR, you are offered the option "Mehrfachtraktion/Multiple traction".
		Press the rotary knob to select the option.
		Turn the rotary knob until "MTR Loks anzeigen/Display MTR locomotives" is displayed.
		Press the rotary knob to display the first locomotive that is part of the MTR.

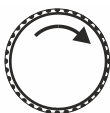

```
Locos in MU 33:
m 1234
```

Turn the rotary knob to scroll through the locomotives that are part of the MTR.

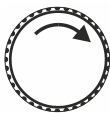

```
Locos in MU 33:
m 0260
```

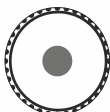

```
▲ m 0260 U 02
Fg0 0
```

Press the rotary knob to select the desired locomotive.

## 10.6 Deleting a locomotive from a multiple traction

You can delete any locomotive that is part of an MTR at any time.



When deleting a locomotive from an MTR, this locomotive must be located on the layout! Only then can the locomotive decoders receive the special MTR commands sent over the track!

If a command to delete does not reach the locomotive decoder (due to bad contact or because you have removed the locomotive from the layout), the MTR address saved in the locomotive decoder is not deleted and the locomotive cannot be operated with its own address.

Action

Display

Explanation

```
▲ MU 33 U 00
```

Call up a locomotive that is part of the MTR or the MTR address itself.



```
Multi unit cons.
```

Press the 'M' key. Since you have selected an MTR or a locomotive that is part of the MTR, you are offered the option "Mehrfachtraktion/Multiple traction".

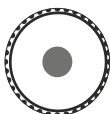

Press the rotary knob to select the option.

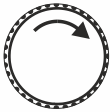

```
MU Locos
delete
```

Turn the rotary knob until "MTR Loks löschen/Delete MTR locomotives" is displayed.

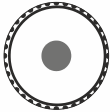

```
MU Loco
delete m 0050
```

Press the rotary knob to display the locomotives in the MTR.



```
MU Loco
delete m 1234
```

Turn the rotary knob to select the locomotive address that you want to delete from the MTR.

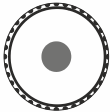

```
▲ L 1234 U 00
Fg0 0
```

Press the rotary knob to confirm your selection. The locomotive is deleted from the MTR.

## 10.7 Deleting a complete MTR

You can also delete the complete multiple traction.



When deleting a complete MTR, all locomotives in the MTR must be located on the layout! Only then can the locomotive decoders receive the special MTR commands sent over the track!

If a command to delete does not reach the locomotive decoder (due to bad contact or because you have removed the locomotive from the layout), the MTR address saved in the locomotive decoder is not deleted and the locomotive cannot be operated with its own address

Action	Display	Explanation
		Call up the multiple traction that you want to delete.
		Press the 'M' key. You are offered the option "Mehrfachtraktion/Multiple traction".
		Press the rotary knob to select the option.
		Turn the rotary knob until "Mehrfachtraktion löschen/Delete multiple traction" is displayed.
		Press the rotary knob. A security query is displayed. Press the 'Esc' key to cancel the process.
		Press the key again to delete the complete MTR.

## 10.8 Error messages relating to multiple tractions

If you made an error when assembling the multiple traction, you receive one of the following messages:

- Error 24: The locomotive was not called up before it was added to the MTR or the locomotive was not given an operating command. You have tried to add a conventional analogue locomotive (address 0) to a multiple traction.
- Error 25: One of the locomotives that you wanted to add to the MTR has already been called up by another manual control.
- Error 26: One of the locomotives that you wanted to add to the MTR is already part of another MTR.
- Error 27: The speed step of one of the locomotives was not 0 when you wanted to add it to the multiple traction.

Press the "<=" key to delete the error message.

---



## 11 Displaying feedback

Use this function to display the status of inputs of LR100/101 feedback modules.

Action	Display	Explanation
		Press the 'M' key. You are offered the option last selected, e. g. multiple traction.
		Turn the rotary knob to display "Rückmeldungen anzeigen/Display feedback".
		Press the rotary knob to select the option. You are asked to enter the feedback address.
		Let us assume that you want to display the 8 digits of feedback address 39.
		Use the '<=' key to correct your entry if necessary. Press 'Enter'. The manual control checks the status of the feedback module with the command station and displays the result.
		The top line displays the address of the read-out feedback module. The bottom line displays the active feedback contacts. "1 3 4 6 8" means that feedback contacts 1,3,4,6 and 8 are enabled.
		Press the '<=' key to enter the address of another feedback module ...
... or ...		
		... press the 'Esc' key to return to "Controlling locomotive".



If you enter a feedback address, but no feedback module with that address is connected to the feedback bus, you see the following display:



 Press the '<=' key to enter the address of another feedback module ...

The valid feedback address range is 1 to 128. If you enter a lower or higher value, you will be asked to enter a feedback address.

## **12 Configuring (programming) decoder settings**

In this large section you will learn:

- what “programming” means in the *Digital plus by Lenz*® system
- what settings can be changed by programming
- what methods can be used for programming
- how to programme

### **12.1 What is programming and what purpose does it serve?**

Programming means changing decoder settings. You may be dealing with a locomotive decoder, an switch decoder or a feedback module.

Each setting is saved in a memory location inside the decoder. These memory locations are similar to index cards in a box. Each decoder has such an “index card box”. Each “card” has one setting of the locomotive decoder written on it, for instance on “card” number 1 the locomotive address, on “card” number 3 the starting delay. In other words, one card for each decoder setting. Depending on the number of settings available in the decoder the “index card box” may be bigger or smaller. Each “card” has a numeric value written on it. The valid range is 0 to 255.

Since you can change the values on these index cards (in these memory locations) again and again, they are also referred to as “variables”. These variables are used to determine – or **configure** – settings. Hence in the US, the term “**Configuration Variable**” (**CV**) was developed. From now on, we will no longer refer to “index cards”, but use the correct term “CV”. CVs are used to describe the settings or the behaviour of a decoder.

Which information is contained in which CV is standardised. E. g. CV1 is always the locomotive address, CV3 is always the starting delay, and CV4 is always the braking delay. A description of the available CVs and their settings is contained in *Digital plus by Lenz*® locomotive decoder manuals or in the "Handbuch Lokdecoder (Art. no. 90005)". This information can be downloaded from the internet ([www.digital-plus.de](http://www.digital-plus.de)), obtained from your model railway dealer, or by sending a stamped, self-addressed envelope to Lenz Elektronik GmbH.

Whether all values between 0 and 255 are available depends on the setting. For CV1 (basic address), the valid range is 1 to 99. For CV53 (dimming function outputs) the valid range is 0 to 255.

There are also "index cards" that contain the entered numeric value in another way of writing to facilitate use. This other way of writing is called **binary writing**. Here, the numeric value is not displayed using the digits 0,1,2,3,4,5,6,7,8,9, but using only the digits 0 and 1.

It is easier to imagine those CVs as a series of 8 switches that can be switched on or off. These switches are referred to as "bits". If the switch is on, we say "the bit is set" or "the bit is 1". If the switch is off, we say "the bit is deleted" or "the bit is 0".

Example: binary display of CV29

In this CV several settings are saved. Whether a certain setting is on or off is determined by one of the 8 switches (bits):

Switch no.	turned on (=bit set "1")	turned off (=bit deleted "0")
1	Locomotive runs backward when direction arrow points 'up'	Locomotive runs forward when direction arrow points 'up'
2	Locomotive operates in 28 step mode	Locomotive operates in 14 step mode
3	Locomotive can also run in analogue operation	Locomotive cannot run in analogue operation
4	Not used	Not used
5	Decoder uses set speed curve	Decoder uses ex-factory speed curve
6	Locomotive is controlled with extended address from CV17 and CV18	Locomotive is controlled with basic address from CV1
7	Not used	Not used
8	Not used	Not used

### 12.1.1 Difference between "Programming in operational mode" and "Programming on the programming track"

When you use **"Programming on the programming track"**, the locomotive may be operating anywhere on your layout. To communicate with this locomotive and tell it from all others, you must know the address of this locomotive. When you use "Programming in operational mode", the locomotive receives a command that can be described like this:

"Locomotive number 1234, enter value 15 in CV4!"

Only the locomotive with address 1234 will carry out this command.

When you use **"Programming on the programming track"** it is not necessary to know the address of the decoder. The decoder receives a command like:

"Write value 15 in CV4!"

Each and every decoder that receives this command will carry it out.

### **12.1.2 When to use "Programming on the programming track"?**

**Whenever you want to change the address of a locomotive decoder.**

There are also ***Digital plus by Lenz***® decoders that are not capable of "Programming in operational mode", e. g. locomotive decoders that were developed before this feature became an NMRA standard, or e. g. switch decoders that do not need this functionality (because these receivers can be fully configured before being installed).

For all these decoders you must use "Programming on the programming track".

## 12.2 Programming in operational mode - PoM

Programming in operational mode is mainly of interest for locomotive decoders, since PoM is used to change the settings of the decoder on the normal "operating" track. The locomotive can be located anywhere on your layout. To change a setting using PoM, the decoder does not have to be placed on a programming track.

To change the settings of a particular locomotive using PoM, you must know the address of this locomotive since all programming commands depend on the locomotive address. The command station sends a command: "Locomotive no. 132 save a starting delay of 10!" This command is carried out only by the locomotive with address 132. If the address is not known or you want to change the address of a locomotive, you must use "Programming on the Programming track " starting on page 68.

### 12.2.1 Which settings can be changed using PoM?

All CVs in a locomotive decoder can be changed using PoM, with the exception of the basic address in CV1 and the extended address in CV17 and CV18. For this reason, you should be careful as you proceed: If you make a mistake in programming, the locomotive may not operate! In day-to-day operation, you will probably change the CVs for the starting and braking delay most often.

### 12.2.2 Which locomotive decoders can have their settings changed using PoM?

All **Digital plus by Lenz** locomotive decoders from the XF and XS series onwards are capable of PoM. If you use locomotive decoders from other manufacturers, please refer to their manuals to check if these are capable of PoM.

Locomotive decoders that are not capable of PoM are programmed on a special programming track. For more information, read the section "Programming on the Programming track " starting on page 68.









### 12.2.3 Programming a numeric value into a CV — step by step approach:

In the following example, we will change the starting delay of the locomotive with address 3 using PoM:

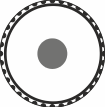
---



Before you switch to PoM, you must call up the address of the locomotive whose settings you want to change!

Action	Display	Explanation
	<pre>▲ L 0001  V 00 Fg0</pre>	Call up the locomotive whose settings you want to change using PoM.
	<pre>Address?  _ Stack1: L 0001</pre>	Press the 'locomotive' key.
	<pre>command station Stack ?</pre>	Press the 'M' key. You are offered the option last used (in this example the locomotive selection from the command station memory).
	<pre>Programmieren the main PoM</pre>	Turn the rotary knob until "Programmieren während des Betriebs PoM/Programming in operational mode PoM" is displayed.
	<pre>PoM CV _</pre>	Press the rotary knob to select the option "PoM". You are asked to enter the CV that you want to change using PoM.
	<pre>PoM CV 0003</pre>	Use the keys to enter the number of the CV ...
		(use the  key to correct your entry if necessary)
	<pre>PoM CV 0003 Value: _</pre>	... and press the 'locomotive' key to complete the entry process.
		You can now enter the desired value...
	<pre>PoM CV 0003 Value: _6</pre>	... in this example value "6".
	<pre>PoM CV 0003 writing... 006</pre>	Press the 'locomotive' key to confirm your entry and to start programming. Alternatively, press the rotary knob.
	<pre>PoM CV 0003 Value: 006</pre>	The value of the CV is displayed.

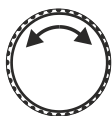

```
PoM      CV 0003
      Value: 027
```

You can now use the rotary knob to change the value. **The new value is immediately entered into the decoder.** This is particularly useful if you want to e. g. change the brightness of the locomotive lighting.



```
PoM      CV 0003
      Value: _
```

Alternatively, press the '<=' key to enter another value using the key pad ...



```
PoM      CV 0003
      Value: 027
```

... and start programming again.



```
PoM      CV _
```

Press the 'Esc' key to return to entering the CV.



```
▲ L 0001  V 00
Fg0
```

Press the 'Esc' key again to return to "Controlling locomotive".

### 12.2.4 Reading out CVs using the LRC120 address display

It is possible to read out CV values via PoM during operation. Requirements:

- use of a RailCom-capable locomotive decoder
- the locomotive is located in a track section monitored by the LRC120 address display
- RailCom transmission is enabled in the decoder

Information on how to connect the LRC120 address display as well as the settings of RailCom-capable locomotive decoders can be found in the respective operating manuals.

Proceed as follows:

Action

Display





Explanation

```
▲ L 0001  V 00
Fg0
```

Call up the locomotive whose settings you want to change using PoM.

Move the locomotive whose CVs you want to read out using PoM to the track section monitored by the LRC120 address display. The address display now shows the address of the locomotive.

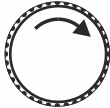
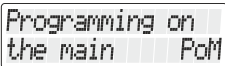
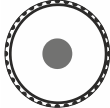

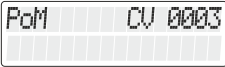
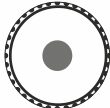
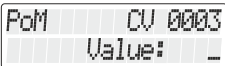
		Press the 'M' key. You are offered the option last used (in this example the multiple traction).
		Turn the rotary knob until "Programmieren während des Betriebs PoM/Programming in operational mode" is displayed.
		Press the rotary knob to select the option "PoM". You are asked to enter the CV that you want to change using PoM.
		Use the keys to enter the number of the CV ...
		... and press the rotary knob to complete the entry process.

The LRC120 address display shows the value of CV3 for approx. 3 seconds.

"c" flashes at the very left of the display; the value is displayed on the right:













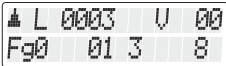

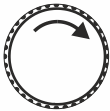

Whenever you enter the number of a CV, a PoM read command is sent to the decoder which sends the content of the respective CV via RailCom. The LRC120 address display receives this information and displays it for approx. 3 seconds.

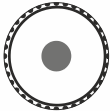
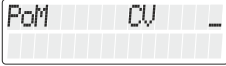
### 12.2.5 Setting and deleting bits (switches) using PoM — step by step approach

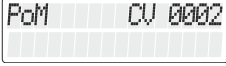
Many CVs do not use numeric values, but individual bits (switches) for particular settings. It is much more comfortable to change a feature by setting or deleting the corresponding bit (switch) than to calculate the corresponding numeric value and to programme it into the CV (which is, of course, also possible).

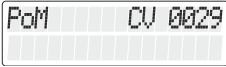
A particularly good example for a CV for which the deleting and setting of bits is the better approach is CV29.

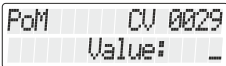
In the following example we will change CV29 in locomotive address 3 using PoM.

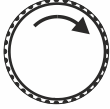
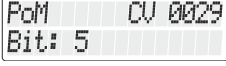
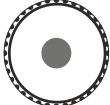
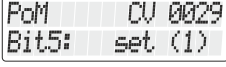
Action	Display	Explanation
		Call up the locomotive whose settings you want to change using PoM.
		Press the 'locomotive' key.
		Press the 'M' key. You are offered the option last used (in this example the setting of the speed step mode).
		Turn the rotary knob until "Programmieren während des Betriebs PoM/Programming in operational mode PoM" is displayed.
		Press the rotary knob to select the option "PoM". You are asked to enter the CV that you want to change using PoM.
		Use the keypad to enter the number of the CV ...
		
		... and press the 'locomotive' key to complete the entry process.
		Press the 'M' key.
		Use the rotary knob to select the bit that you want to change.
		Press the rotary knob to confirm your selection.

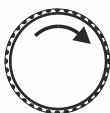

```
PoM    CV 0029
Bit5: erase (0)
```

Turn the rotary knob to set the bit (1) or to delete the bit (0).

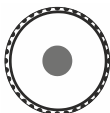

```
PoM    CV 0029
Bit5: erase (0)
```

Press the knob to start programming.

```
PoM    CV 0029
writing... (0)
```

While programming you see this display.

```
PoM    CV 0029
Bit5: erase (0)
```



```
PoM    CV 0029
Bit: 5
```

Press the 'Esc' key to return to selecting the bit ...



```
PoM    CV _

```

... press the 'Esc' key again to select the CV.

You can now select another CV that you want to change or ...



```
▲ L 0003 U 00
Fg0 01 3 8
```

... return to "Controlling locomotive".

## 12.3 Programming on the Programming track

As explained above, programming means changing the settings of decoders.

Depending on the decoder setting that you want to change, two menus are available to facilitate handling:

### Programmieren Adresse/Programming Address



This is the easiest way to determine or change a decoder address. You do not need to know in which CVs the values for the address have to be entered, the process is the same for all addresses.

### Programmieren CV/Programming CV



This menu is used for all other CVs that you want to change.

#### 12.3.1 What is a programming track?

When using "Programming on the programming track" it is not necessary to know the decoder address. The decoder receives a command like:

"Enter value 15 in CV4!"

To ensure that only one particular decoder receives the programming command, you must make sure while programming on the programming track that only this decoder receives this command. This is done by using a track that is electrically isolated from the rest of the layout, the so-called "programming track", on which you place only the locomotive whose decoder settings you want to change.

#### 12.3.2 Where to connect the programming track/the decoder?

The Digital plus command stations LZ100, LZV100 and LZV200 have special connection terminals for the programming track (or the decoder). These connections are labelled P and Q. More information can be found in the operation manual of the respective command station.

### 12.3.3 Reading out and changing a locomotive address

Step-by-step approach to reading out a locomotive address:

Action	Display	Explanation
		Proceed from "Controlling locomotive".
		Change to the general menu.
		Select "Programmieren on Programmiergleis/Programming on the programming track" ...
		... and confirm your selection.
		Turn the rotary knob until "Programmieren Lokadresse/Programming locomotive address" is displayed...
		... and confirm your selection. The locomotive address is read out. This takes a few seconds.
		If the address was successfully read out, it will be displayed. If an error occurred during the reading-out process, you will receive an error message (⇒ p. 74).
		If you want to change the displayed address, you will have to clear the display first.
		Now enter the desired new address using the keypad...
		(press the  key to correct your entry if necessary).

4

```
Prog. loco addr.
      1234
```



```
Prog. loco addr.
writing... 1234
```

Press the 'locomotive' key to complete the entry process.

The desired address is now entered into the locomotive decoder.

```
Prog. loco addr.
L 0003
```

The locomotive address is displayed.

If an error occurred during the entry process, you will receive an error message (⇒p. 74).

Now, press



```
Prog. loco addr.
      _
```

to enter another locomotive address

or



```
Programming
Loco address
```

to move one step upwards in the menu.



2-digit addresses (1-99) are saved in CV1, 4-digit locomotive addresses (100-9999) are saved in CV17 and CV18. While in the menu "Programmieren Lokadresse"/"Programming locomotive address", you do not have to think about this. All necessary settings are made automatically!



If you see this display while reading out the address,

```
Prog. loco addr.
m 5678 MTR 33
```

multiple traction address 33 is programmed in the locomotive decoder with address 5678 and the locomotive is set to operate with the MTR address 33.







If you enter a new address, the MTR address will be deleted!

### 12.3.4 Reading out and programming a CV

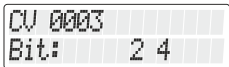
Action	Display	Explanation
		Proceed from "Controlling locomotive".
		Change to the general menu.
		Select the relevant menu entry
		... and confirm your selection.
		Turn the rotary knob until "Programmieren CV/Programming CV" is displayed ...
		... and confirm your selection. You are asked to enter the CV whose value you want to read out or change.
		Enter the number of the CV using the keypad ...
		(press the  key to correct your entry if necessary)
		... press the 'locomotive' key to complete the entry process.
		The CV is read out and the result displayed.

Now, you have the following options:

- a) Enter another value in the CV

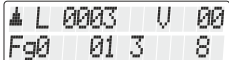
- or
- b)   change to the binary display (and changing the value)
- or
- c)   select another CV
- or
- d)     
  return to "Controlling locomotive".



#### 12.3.4.1 Binary (bitwise) displaying and changing of the CV value

There are two different ways of entering (or displaying) the desired value in the CV: Decimal or bitwise (binary). You can choose your preferred method. However, there are CVs for which bitwise entry is easier; for other CVs decimal entry is the recommended.

Example:



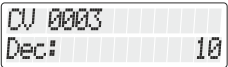

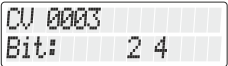
In CV29, decoder settings are configured by setting or deleting bits. Here, bitwise entry is recommended.

First, read out the content of the desired CV. Proceed as described in the section "Reading out and programming a CV", page 71.

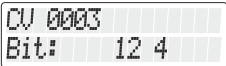

-  After the result is displayed, change to the bitwise (binary) display of the decimal numeric value.
-   The bottom line of the display indicates which bits are set. For decimal value 10 these are bits 2 and 4 (counting starts at 1).

If you want to make changes, press the corresponding number keys. In the following example, bit 1 is to be set additionally while bit 2 is to be deleted:



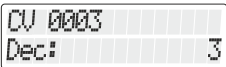

- 1**  Press key '1' to set the corresponding bit 1.
- 4**  Press key '4' to delete the corresponding bit 4.
-   Press the 'locomotive' key to start programming.

You can change between the bitwise and the decimal display of the value at any time:

- F**  Decimal display
- F**  Bitwise display

Now, you have the following options:

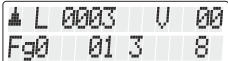
- a) **Esc**  Select another CV
- or
- b) **Esc**  return to "Controlling locomotive".
- Esc** 

Make sure you do not exceed the valid value range of the decoder when entering the numeric value in the CV! If needed, refer to the operating manual of the decoder. CV7 (version number) and CV8 (manufacturer identification) can only be read out, but not entered.

## 12.4 Error messages while programming on the programming track

If an error occurred during programming or reading out process, you will receive an error message:

- Error 1     While programming or reading out a decoder, a power overload (short circuit) was detected. The decoder may not be correctly connected or may be defective.
- Error 2     When programming or reading out a decoder, no decoder reaction was detected. The decoder may not be correctly connected to the programming output of the LZ100/LZV100 command station (e. g. the digital locomotive may not be properly placed on the programming track).

Press the



key to delete the error message.

### 12.4.1 Display of other connected manual controls

While the command station is in programming mode, the displays of the **other** manual controls shows a corresponding message.

I.e. another LH101 will display

```
!command stat. i!  
programming mode
```

in that situation.

---

## 13 LH101 setup (device setting)

This section describes the possible settings of the LH101. These are permanently saved in the LH101.

### 13.1 Setting the speed step mode

To control direction and speed, two methods are available:

- **Standard mode:**  
In this mode (ex-factory setting) you can decrease the speed step to 0 using the rotary knob.
- **Shunting mode:**  
In this mode you can decrease the speed step to 1 using the rotary knob. Press the rotary knob to stop the locomotive. Let the locomotive move slowly to the desired location and press the rotary knob to stop the locomotive.  
The advantage of this mode while shunting: You can decrease the speed to the slowest setting without risking that the locomotive stops to early and **without having to look at the manual control**.



Do not confuse the shunting *mode* of the LH101 with the *shunting gear* that can be set in locomotive decoders.

To set the shunting mode:

Action	Display	Explanation
		Turn the rotary knob until the option "Setup LH101/LH101 setup" is displayed.

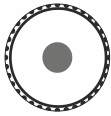

Press the rotary knob to select this option.



```
Control mode
select
```

Turn the rotary knob until the option "Fahrmodus einstellen/Setting speed step mode" is displayed and press the rotary knob.

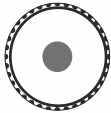

```
Control mode
Normal
```

The current setting is displayed. (ex-factory setting is "standard").

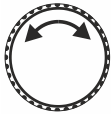

```
Control mode
Shunting
```

Turn the rotary knob to select the desired setting ...

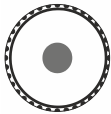

```
▲ L 0003 V 05
Fg0 01 3 8
```

... press the rotary knob to confirm your selection.

The setting is saved and the LH101 returns to "Controlling locomotive".

## 13.2 Setting the club mode

### What is the club mode?

Let us assume that you want to operate your model railway layout together with other model railway enthusiasts.

In this context you want to give the LH101 manual control to somebody who has never used that device. You can facilitate the use of the manual control by "hiding" the majority of operating options.

Or you want to prevent a co-player from selecting a locomotive other than the one assigned to him or to effect other system settings.

To this end, three different modes are available:

**Mode 1:** It is possible to control the locomotive set and to switch functions 0 to 9. It is also possible to switch points and signals.

All other operating options are blocked.

**Mode 2:** It is possible to control the locomotive set and to switch functions 0 to 9.

All other operating options are blocked.

**Mode 0:** This is the ex-factory setting. The entire range of operating options is available.

Mode 1 and mode 2 are secured by a password (a four-digit number). This password is required to return to mode 0.



### Note down the password.

If you forget the password, it is no longer possible to set mode 0.

If you have forgotten the password and require help, please contact our customer support.

## 13.2.1 Setting club mode 1 or 2

Action	Display	Explanation
		Select the locomotive address that you want to operate in club mode 1 or 2.
		Press the 'M' key.
		Turn the rotary knob until the option "Setup LH101/LH101 setup" is displayed.
		Press the rotary knob to select this option.
		Press the rotary knob until the option "Clubmodus/Club mode" is displayed.

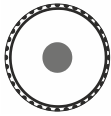

Press the rotary knob to select this option.



```
Selection
Club mode 1
```

You can now choose between "Clubmodus 1/Club mode 1" and " Clubmodus 2/Club mode 2".

(If the LH01 is in mode 1 or 2, this menu is not available).

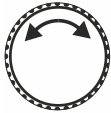

```
Selection
Club mode 2
```

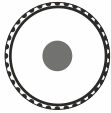

```
Password?
```

Press the rotary knob to select the desired club mode.

You are asked to enter a four-digit number as password.

```
Password? 3456
```

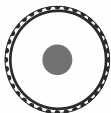

```
Password 3456
saved
```

Press the rotary knob to complete the process.

```
▲ L 0003 U 05
Fg0 01 3 8
```

The LH101 returns to "Controlling locomotive". The restrictions of the selected club mode are enabled.

### 13.2.2 Setting mode 0

If you want to reset the LH101 that is in club mode 1 or 2 to the "standard" mode, proceed as follows:

Action	Display	Explanation
	<pre>▲ L 0003 U 05 Fg0 01 3 8</pre>	Proceed from "Controlling locomotive" (address or speed step are displayed)...
<b>M</b>		... press the 'M' key and <b>keep it pressed until ...</b>

... "Passwort?/Password?" is displayed.

Release the button to enter the password (which we hope you remember ☺).

If you have entered the correct password, "Clubmodus 0 aktiviert/Club mode 0 enabled" is displayed.

The LH101 returns to "Controlling locomotive". The locomotive address or the speed step are displayed. The entire function range is available again.

If you have entered an incorrect password, this error message is displayed when you press the button.

The LH101 remains in the selected club mode and returns to "Controlling locomotive". The locomotive address or the speed step are displayed. Repeat the above procedure, entering the correct password.

### 13.3 Counting method for bit representation

The section "Setting and deleting bits" described how to change individual bits in CVs. When doing so, bits are counted starting at 1.

Some decoders of other manufacturers may start counting bits at 0. To ensure that you get a display corresponding to this counting method, you can set the counting method for the bit representation.

Action

Display

Explanation

Select the locomotive address that is to be operated in club mode 1 or 2.



Press the 'M' key.

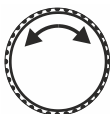

Turn the rotary knob until the option "Setup LH101/LH101 setup" is displayed.

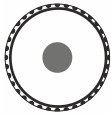

Press the rotary knob to select this option.



```
How to count the
bits in display
```

Turn the rotary knob until the option "Zählweise Bitdarstellung/Counting method bit representation" is displayed.

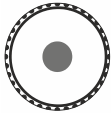

```
count the bits
1 to 8
```

Press the rotary knob to select this option. The current setting is displayed.

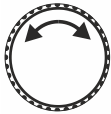

```
count the bits
0 to 7
```

Turn the rotary knob to select an option ...

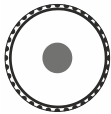

```
How to count the
bits in display
```

... and press the rotary knob to confirm your selection.

**Esc**

```
Setup LH101
```

Return to setup ...

**Esc**

```
▲ L 0003 U 05
Fg0 01 3 8
```

... and "Controlling locomotive".

## 13.4 Display brightness

Use this option to set the brightness of the LCD background lighting.

Action

Display

Explanation

```
▲ L 0003 U 05
Fg0 01 3 8
```

Select the locomotive address that is to be operated in club mode 1 or 2.

**M**

Press the 'M' key.



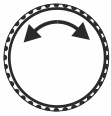

```
Setup LH101
```

Turn the rotary knob until the option "Setup LH101/LH101 setup" is displayed.

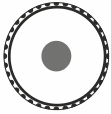

Press the rotary knob to select this option.



```
Brightness
Display
```

Turn the rotary knob until the option "Helligkeit Display/Display brightness" is displayed.

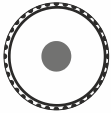

Press the rotary knob to select this option.

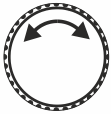

```
Brightness
70%
```

Turn the rotary knob to set the display brightness. You can see the result immediately.

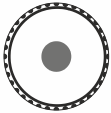

```
Brightness
saved
```

Press the rotary knob to confirm the setting.

```
Brightness
Display
```

**Esc**

```
Setup LH101
```

**Esc**

```
▲ L 0003 U 05
Fg0 01 3 8
```

## 13.5 Display contrast

Action	Display	Explanation
		Select the locomotive address that is to be operated in club mode 1 or 2.
		Press the 'M' key.
		Turn the rotary knob until the option "Setup LH101/LH101 setup" is displayed.
		Press the rotary knob to select this option.
		Turn the rotary knob until the option "Kontrast Display/Display contrast" is displayed.
		Press the rotary knob to select this option.
		Turn the rotary knob to set the display contrast. You can see the result immediately.
		Press the rotary knob to confirm the setting.

## 13.6 Displaying the version number

Action	Display	Explanation
		Select the locomotive address that is to be operated in club mode 1 or 2.
		Press the 'M' key.
		Turn the rotary knob until the option "Setup LH101/LH101 setup" is displayed.
		Press the rotary knob to select this option.
		Turn the rotary knob until the option "Versionsnummer anzeigen/Displaying versions number" is displayed.
		Press the 'Esc' key to move up one level in the menu ...
		... until you return to "Controlling locomotive".

## 13.7 Setting the XpressNet address

All input devices connected to the XpressNET must have their own *device address* to ensure the correct exchange of information with the command station. You must therefore make sure that all connected devices have different device addresses. You can connect up to 31 devices to the XpressNET. Each device must have a unique address between 1 and 31. Ex-factory, each LH101 manual control is programmed to device address 01. If you want to use two or more manual controls, you must programme different addresses for each manual control.

Action	Display	Explanation
		Select the locomotive address that is to be operated in club mode 1 or 2.
		Press the 'M' key.
		Turn the rotary knob until the option "Setup LH101/LH101 setup" is displayed.
		Press the rotary knob to select this option.
		Turn the rotary knob until the option "XpressNet Adresse einst./Setting the XpressNet address" is displayed.
		Use the rotary knob to change the value. You must not use an address that has already been set at another device!

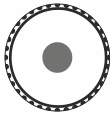

```
Address
saved
```

Press the rotary knob to save the displayed value.

```
XpressNet
program. address
```

Return to the menu "XpressNet Adresse einst./Setting the XpressNet address".

**Esc**

```
▲ L 0003  V 05
Fg0  01 3  8
```

Press the 'Esc' key to return to "Controlling locomotive".

## 13.8 Reset to ex-factory setting

Action

Display

Explanation

```
▲ L 0003  V 05
Fg0  01 3  8
```

Select the locomotive address that is to be operated in club mode 1 or 2.

**M**

Press the 'M' key.

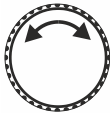

```
Setup LH101
```

Turn the rotary knob until the option "Setup LH101/LH101 setup" is displayed.

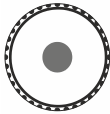

Press the rotary knob to select this option.



```
Reset to
Factory defaults
```

Turn the rotary knob until the option " Reset to factory defaults" is displayed.

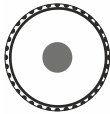

```
LH101 completely
reset t. default?
```

A security query is displayed. Press the 'Esc' key to cancel the process.

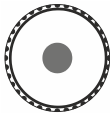

```
LH101 will be
reseted...
```

Press the key again to reset the device to the ex-factory setting.

This takes a few seconds ...

```

▲ L 0001  V 00
Fg0

```

... the device restarts.







### Routes

Routes saved in the LH101 will be available even after a reset to the ex-factory setting.

## 13.9 Route interval

This setting determines the time lag with which switch commands of a route are sent to the command station. The settable range is 300ms (0.3s) to 2750ms (2.75s).

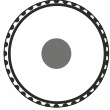
The ex-factory setting is 300ms. If individual points in a route do not switch, increase the route interval in steps of 100ms.

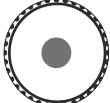
Action	Display	Explanation
	<pre> ▲ L 0003  V 05 Fg0  01 3  8 </pre>	Select the locomotive address that is to be operated in club mode 1 or 2.
		Press the 'M' key.
	<pre> Setup LH101 </pre>	Turn the rotary knob until the option "Setup LH101/LH101 setup" is displayed."
		Press the rotary knob to select this option.
	<pre> Time set route </pre>	Turn the rotary knob until the option "Fahrstrassenzeit/Route interval" is displayed.
	<pre> Time set route 500 ms </pre>	Press the rotary knob to display the current setting (ex-factory setting is 500ms).

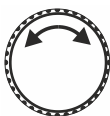

```
Time set route
1000 ms
```

Turn the rotary knob to set the desired interval. Times between 250ms and 1500ms can be set.

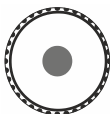

```
Time set route
saved
```

Press the rotary knob to confirm your selection. You receive a confirmation.

```
Time set route
```

**Esc**

```
Setup LH101
```

Press the 'Esc' key to move up one level in the menu ...

**Esc**

```
▲ L 0003 V 05
Fg0 01 3 8
```

... until you return to "Controlling locomotive".

## 14 System setup









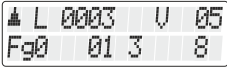

System settings are settings that do not only affect individual locomotives but the entire digital system.

These settings are saved permanently in the command station (LZ100/LZV100/LZV200).

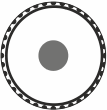
### 14.1 Enabling and disabling the "AUTO" mode

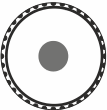
The "AUTO" mode is a special feature of the LZ100/LZV100/LZV200 command stations. When enabled, the command station remembers the speed of called-up locomotives even after turnoff. After turnon, all locomotives will start with their previous speed.

To enable the mode:

Action	Display	Explanation
		Proceed from "Controlling a locomotive".
		Change to the general menu.
		Turn the rotary knob until the option "Setup System/System Setup" is displayed.
		Press the rotary knob to select this option.
		Turn the rotary knob until the option "AUTO"-Mode.
		The current status of the "AUTO" mode is displayed (ex-factory, the mode is disabled).
		Turn the rotary knob to change the setting ...



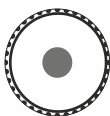

```
▲ L 0003 V 05
Fg0 01 3 8
```

... and press the button to confirm the setting. Press the 'ESC' key to leave the menu without changing the setting.

The LH101 returns to "Controlling locomotive".

### 14.1.1 System behaviour with "AUTO" mode enabled

If you turn the LZ100/LZV100/LZV200 command station on while the "AUTO" mode is enabled, you will see the following display:

```
"AUTO"-Mode is
activated
```

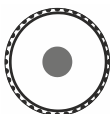

```
▲ L 0003 V 05
Fg0 01 3 8
```

If you want your locomotives to accelerate at their previous speed, press the rotary knob.

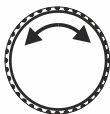

```
"AUTO"-Mode is
deactivated
```

If you don't, turn the rotary knob and confirm the setting.

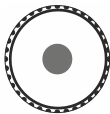

```
▲ L 0003 V 00
Fg0 01 3 8
```

Now, the speed information saved in the LZ100/LZV100/LZV200 command station is deleted. The direction and function information is saved.

## 14.2 Displaying the system version number

Action

Display

Explanation

```
▲ L 0003 V 05
Fg0 01 3 8
```

Select the locomotive address that is to be operated in club mode 1 or 2.



Press the 'M' key.

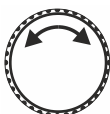

```
Setup System
```

Turn the rotary knob until the option "Setup System/System setup" is displayed.

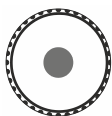

Press the rotary knob to select this option.

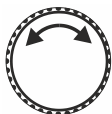

```
Version number
showing
```

Turn the rotary knob until the option "Versionsnummer anzeigen/Displaying version number" is displayed.

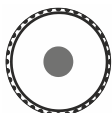

```
command station
Version 3.6
```

**Esc**

```
Version number
showing
```

**Esc**

```
Setup System
```

**Esc**

```
▲ L 0003 U 05
Fg0 01 3 8
```

### 14.3 Deleting locomotive addresses from the command station memory

The LZ100/LZV100/LZV200 command station repeatedly sends operating data to all locomotive addresses contained in its memory.

To avoid sending more addresses than necessary (and to optimise the reaction time), you can delete locomotive addresses from the memory that are not required for operation.

To delete locomotive addresses from the command station memory, proceed as follows:

Action

Display

Explanation

```
▲ L 0003 U 05
Fg0 01 3 8
```

Select the locomotive address that is to be operated in club mode 1 or 2.

**M**

Press the 'M' key.

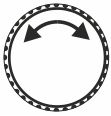

```
Setup System
```

Turn the rotary knob until the option "Setup System/System setup" is displayed.

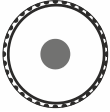

Press the rotary knob to select this option.

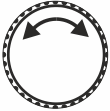

```
Loco addr. from  
stack delete
```

Turn the rotary knob until the option "Lokadresse aus Zentralenspeicher löschen/Deleting locomotive address from the command station memory" is displayed.

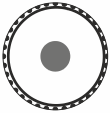

```
Loco address  
delete L 0260
```

Press the rotary knob to select this option. The first locomotive in the command station memory is displayed.

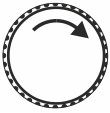

```
Loco address  
delete L 1234
```

Turn the rotary knob to select the locomotive address that you want to delete ...

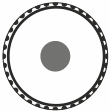

```
Loco address  
deleted
```

... press the rotary knob to confirm your selection.

The confirmation is displayed.

```
Loco addr. from  
stack delete
```

**Esc**

```
Setup System
```

**Esc**

```
▲ L 0003 U 05  
Fg0 01 3 8
```

Press the 'Esc' key several times to return to "Controlling locomotive".

### Possible error messages:

```
no Loco address  
in stack !
```

If no locomotive addresses are saved in the command station memory, you will receive this error message.

```
Setup System
```

The message will disappear automatically; you are back in the system setup.

Esc

▲	L	0003	U	05
Fg0	01	3	8	

Press the 'Esc' key to return to "Controlling locomotive".



Proceed with care when deleting a locomotive address from the command station memory. If an address is deleted, the command station will no longer send data to the locomotive. In case of a power interruption, the locomotive may lose the information.

## 15 Appendix

This appendix contains information that may be of interest to the advanced user, or that may help you if you experience problems.

### 15.1 Error messages on the display

The LH101 will display an error message if you have done something that was not allowed at that time.

To return to the previous step, press



Prog Lokadresse  
Error 1



Here is the list of possible error messages:

Error	Explanation
Error 01	While programming or reading out a decoder, a power overload (short circuit) was detected. The decoder may not be correctly connected or may be defective.
Error 02	While programming or reading out a decoder, no information was detected. The decoder may not be correctly connected to the programming output of the LZ100/LZV100 command station (e. g. the digital locomotive may not be placed properly on the programming track).
Error 24	DTR/MTR: Locomotive not called up or locomotive address 0
Error 25	DTR/MTR: Locomotive called up by another device
Error 26	DTR/MTR: Locomotive already part of another DTR/MTR
Error 27	DTR/MTR: Locomotive speed not 0
Error 30	Locomotive cannot be deleted from command station memory
Error 31	Command station memory full: Delete one (or several) locomotive addresses from the command station memory (see section "Deleting locomotive addresses from the command station memory").
Error 97	There is a data processing error in the LZ100/LZV100 command station. All information about speed, direction and special functions of the locomotives as well as about the status of points and occupancy detectors has been deleted. If this error appears repeatedly, the battery in the LZ100/LZV100 command station may be dead. Please contact your model railway dealer or Lenz Elektronik for replacement.
Error 98	The command sent from the manual control to the command station is not available in its list of commands. The cause is usually a software version of the command station that does not support this command.

---

Error 99	General system error. The manual control did not receive the expected response to a query or command sent to the command station. The cause may be interference on the XpressNET. Please check if all wires are connected correctly. If this does not solve the problem, it is possible that the command station or the manual control are defective. Please contact your model railway dealer or Lenz Elektronik.
----------	--

---

## 15.2 Routes form

Route no. _____		
Step	Address	+/-
1		
2		
3		
4		
5		
6		
7		
8		
9		
10		
11		
12		
13		
14		
15		
16		

Route no. _____		
Step	Address	+/-

## 15.3 Trouble shooting

Problem	Possible cause	Solution
Locomotive does not run	Wrong locomotive address on the display	Enter correct locomotive address. (⇒ p. 17)
Locomotive address on the display, but pressing operating keys yields no response	You are in the address selection mode of the command station memory, indicated by an "A" in the bottom line.	Press 'Enter'.
Speed step mode cannot be changed	Locomotive speed is not 0	Set the speed to 0 <b>before</b> setting the speed step mode.
Locomotive lighting (F0) goes on and off when speed steps are increased	The locomotive decoder is set to the 14 speed step mode, the corresponding address in the digital system is set to the 28 speed step mode.	Change the speed step mode in the system to 14 speed steps (⇒ p. 25) or set the decoder to 28 speed steps (set bit 2 in CV29)
Locomotive lighting (F0) does not respond when pressing 	The locomotive decoder is set to the 28 speed step mode, the corresponding address in the system is set to the 14 speed step mode.	Change the speed step mode in the system to 28 speed steps (⇒ p. 25) or set the decoder to 14 speed steps (clear bit 2 in CV29).
	The locomotive decoder is set to the 14 speed step mode, the corresponding address in the system is set to the 128 speed step mode	Change the speed step mode of the locomotive decoder to 28 speed steps (set bit 2 in CV29).
Locomotive address on the display flashes	Selected address has already been called up by another manual control	Select another locomotive or take over the locomotive by pressing the rotary knob.
Locomotive does not run with its basic address read out on the programming track	Locomotive may be part of a multiple traction. The MTR address can be found in CV19 of the locomotive decoder.	Control the locomotive with the multiple traction address or delete the MTR address in CV19.
	The locomotive is set to operation with a 4-digit address (bit 6 is set in CV29).	Control the locomotive with the 4-digit address. If you do not know the address, read it out on the programming track. Information on how to proceed

























































---

		can be found on page 69.
"STOP" flashes on the display.	An emergency stop was initiated by another manual control.	Press the rotary knob to cancel the emergency stop.
"OFF" flashes on the display.	An emergency off was initiated by another manual control.	Press the rotary knob to cancel the emergency off.
	An amplifier has triggered an emergency off due to a short circuit or a power overload.	Remove the short circuit. In case of a power overload, divide the layout into several power sections. Read section "The power supply of a model railway layout" in the operating manual of the LZV100 command station or the LV102 amplifier.

---

## 15.4 Tree structure of options of the LH101

			Select locomotive address from the LH101 stack	
	<b>M</b>			Select locomotive address from the command station memory
				PoM
				Select speed step mode
<b>F</b>			Change function group	
<b>F</b>			Press longer: Configure functions	
			Configure "refresh" of functions	
			Set permanent/temporary operation	
<b>Y</b>			Switch points/signals	
			Call up routes	
	<b>M</b>		Create and edit routes	
<b>M</b>			Double traction	
			Multiple traction	
			Display feedback	
			Programming on the programming track	
				Programming locomotive address
				Programming CV
			LH101 setup	
			Set operating mode	
			Club mode	
			Counting method bit representation	
			Brightness display	

		Contrast display
		Display version number
		Set XpressNet address
		Reset to ex-factory setting
		Route interval
		System setup
		"AUTO" mode
		Display system version number
		Delete locomotive address from memory

Not suitable for children under fourteen because of the danger of their swallowing the small constituent pieces. Improper use can result in injury by functionally necessary points and edges. For use only in dry areas. We reserve the right to make changes in line with technical progress, product maintenance or changes in production methods. We accept no responsibility for errors which may occur for similar reasons. We accept no responsibility for direct or indirect damage resulting from improper use, non-observance of instructions, use of transformers or other electrical equipment which is not authorised for use with model railways, or transformers or other electrical equipment which has been altered or adapted or which is faulty. Nor can we accept responsibility when damage results from unsupervised adjustments to equipment or from acts of violence or from overheating or from the effects of moisture etc.

Furthermore, in all such cases guarantees become invalid.

# **Lenz**

## **ELEKTRONIK GMBH**

Vogelsang 14

35398 Giessen

Hotline: 06403 900 133

Fax: 06403 900 155

[www.lenz-elektronik.de](http://www.lenz-elektronik.de)

[support@lenz-elektronik.de](mailto:support@lenz-elektronik.de)



Keep this operating manual for later use!

---